

---

**ME M2 M6**

---

Kitchen portraits

---

**MESON'S**



**MESON'S**

**La passione di progettisti e tecnici.  
La ricerca estetica e funzionale, la storia,  
la tecnologia e l'attenzione all'ambiente.  
Nelle collezioni ME, M2 e M6 c'è tutto  
questo. Uno stile unico che combina  
qualità, cura dei dettagli e l'inconfondibile  
gusto italiano. Questa è Meson's.  
Benvenuti nella galleria di famiglia.**

<sup>EN</sup> The passion of designers and technicians. Aesthetic and functional research, history, technology and attention to the environment. All of this is featured in the ME, M2 and M6 collections. A unique style which combines quality, attention to detail and undeniable Italian taste. This is Meson's. Welcome to the family gallery.

<sup>FR</sup> La passion des designers et des techniciens. Recherche esthétique et fonctionnelle, histoire, technologie et attention pour l'environnement. Voilà tout ce que l'on retrouve dans les collections ME, M2 et M6. Un style unique qui allie qualité, soin des détails et l'incomparable goût italien. Meson's, c'est tout cela. Bienvenue dans la galerie de famille.

<sup>DE</sup> Die Leidenschaft von Plänern und Technikern. Die Suche nach Ästhetik und Funktionalität, Technologie und Umweltbewusstsein. In den Küchenmodellen ME, M2 und M6 steckt all das. Ein einzigartiger Stil, der Qualität, Liebe zum Detail und den unverwechselbaren italienischen Geschmack miteinander kombiniert. Das ist Meson's. Willkommen in der Galerie unserer Produktfamilien.

<sup>ES</sup> La pasión de los diseñadores y técnicos. Investigación estética y funcional, historia, tecnología y atención al medio ambiente. Las colecciones ME, M2 y M6 contienen todo esto. Un estilo único que combina la calidad, la atención al detalle y el inconfundible sabor italiano. Esto es Meson's. Bienvenido a la galería familiar.

# Index

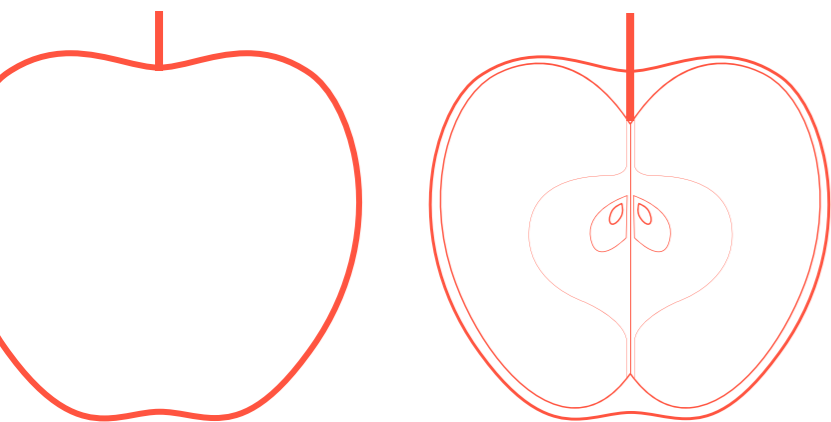

---

## ME

ME Slim  
p. 8

ME Trim  
p. 32

ME Murano  
p. 44

ME Materia  
p. 52

## M2

M2 Goccia  
p. 64

M2 Linea  
p. 78

M2 Crea  
p. 104

M2 Monoliti  
p. 110

M2 Memo  
p. 116

## M6

M6 Vela  
p. 124

M6 Presa  
p. 130

M6 Profili  
p. 134

# ME: Slim Trim Murano Materia

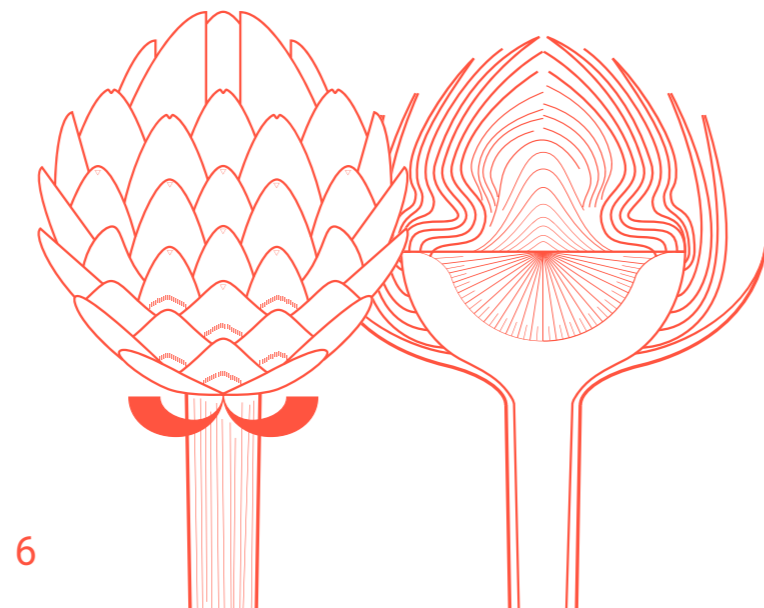

ME Slim p.8

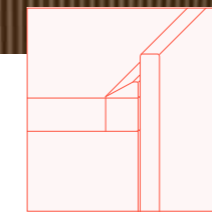

ME Murano p.44



ME Trim p.32

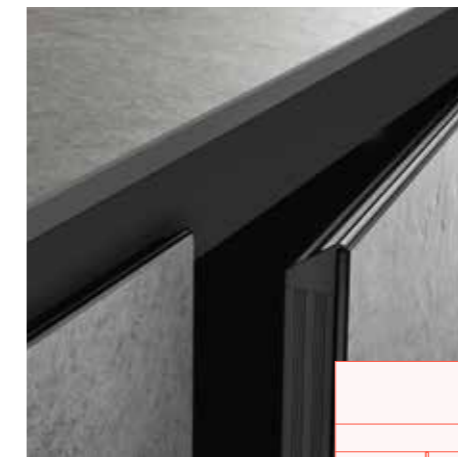
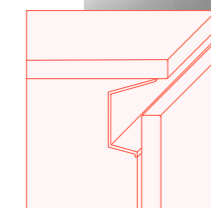

ME Materia p.52

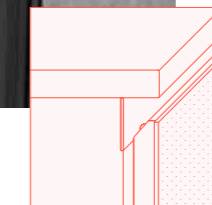

# ME Slim

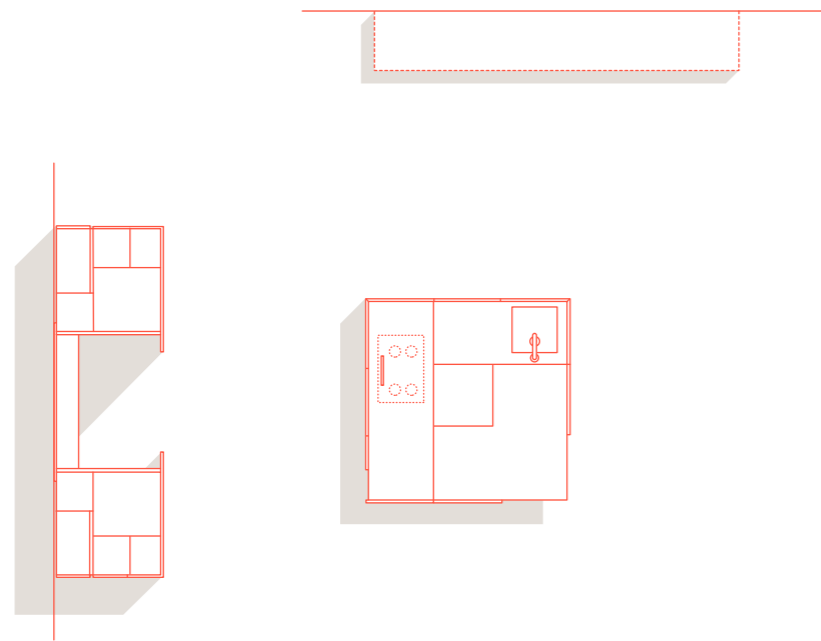

Essenza  
Fresata  
Ambra



Lapitec  
Musa  
Elettra  
Satin

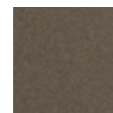

Laccato  
Ossidato  
Cacao



Essenza  
Premium  
Ambra



Essenza Fresata Ambra /  
Ambra Milled Veneer /  
Plaqué Fraisée Ambra /  
Ambra Gemahlene Holz /  
Contrachapado con ranura  
Ambra



Lapitec Musa Elettra  
Satin



Laccato Ossidato Cacao /  
Cacao Oxidized Lacquer /  
Laqué Oxydé Cacao / Cacao  
Oxidiert Lackiert /  
Lacado Oxidado Cacao



Essenza Premium Ambra /  
Ambra Premium Veneer /  
Plaqué Premium Ambra /  
Ambra Premium-Furnierholz /  
Contrachapado Premium Ambra





IT Una combinazione di forme, volumi e toni rappresentativa del carattere della collezione Slim. Un'immagine che vuole trasmettere la freschezza e la leggerezza di un nuovo vocabolario progettuale.



EN A combination of shapes, volumes and tones that defines the character of the Slim collection. An image that seeks to convey the freshness and lightness of a new vocabulary.

FR Une combinaison de formes, de volumes et de tons représentatifs du caractère de la collection Slim. Une image destinée à transmettre la fraîcheur et la légèreté d'un nouveau vocabulaire de design.

DE Eine Kombination aus Formen, Volumen und Tönen, die den Charakter der Slim-Kollektion repräsentiert. Ein Bild, das die Frische und Leichtigkeit eines neuen Designvokabulars vermitteln soll.

ES Una combinación de formas, volúmenes y tonos representativos de la colección Slim. Una imagen que desea transmitir la novedad y ligereza de un nuevo diseño.







# ME Slim

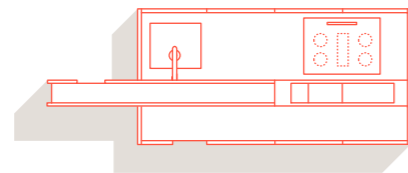
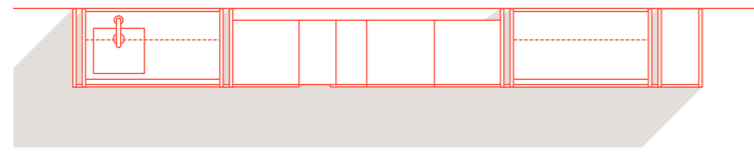

Laccato Ossidato Lava / Laminam In-side Cardoso Grigio Fiammato / Laccato Opaco Efeso FX / Fenix Grigio Bromo



Laccato Ossidato Lava / Lava Oxidized Lacquer / Laqué Oxydé Lava / Lava Oxidiert Lackiert / Lacado Oxidado Lava

Laminam In-side Cardoso Grigio Fiammato

Laccato Opaco Efeso FX / Efeso FX Matt Lacquer / Laqué mat Efeso FX / Efeso FX Matt Lackiert / Lacado Mate Efeso FX

Fenix Grigio Bromo





IT Una casa dal carattere deciso, una composizione in cui le colonne a tutta altezza si fondono nello spazio come una quinta e l'isola scultorea, dai volumi sospesi, dona all'insieme un tratto scenografico.

EN A strong-charactered home, a composition in which the full-height tall units blend into the space like a backdrop and the sculptural island, with its suspended volumes, gives the space a scenic feel.

FR Une maison au caractère affirmé, une composition dans laquelle les colonnes toute hauteur se fondent dans l'espace comme une toile de fond et l'îlot sculptural, avec ses volumes suspendus, donne à l'ensemble un caractère scénique.

DE Ein Haus mit starkem Charakter, eine Komposition, bei der sich die raumhohen Säulen wie eine Kulisse in den Raum einfügen und die skulpturale Insel mit ihren schwebenden Volumen dem Ganzen einen szenischen Charakter verleiht.

ES Una casa con un fuerte carácter, una composición donde las columnas de toda altura se funden con el espacio como un telón de fondo y la isla escultórica, con sus volúmenes suspendidos, todo eso da al conjunto un carácter escénico.





# ME Slim

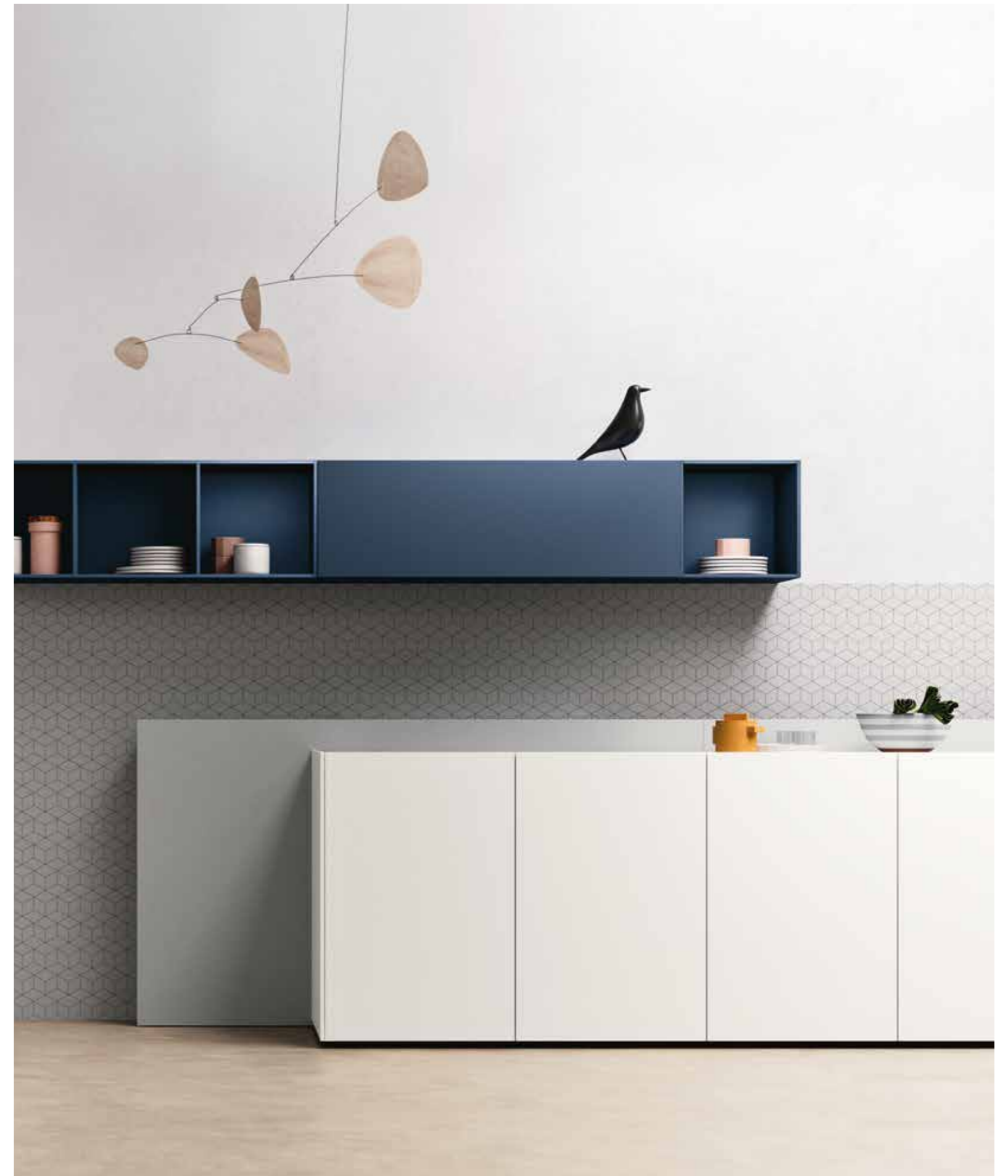
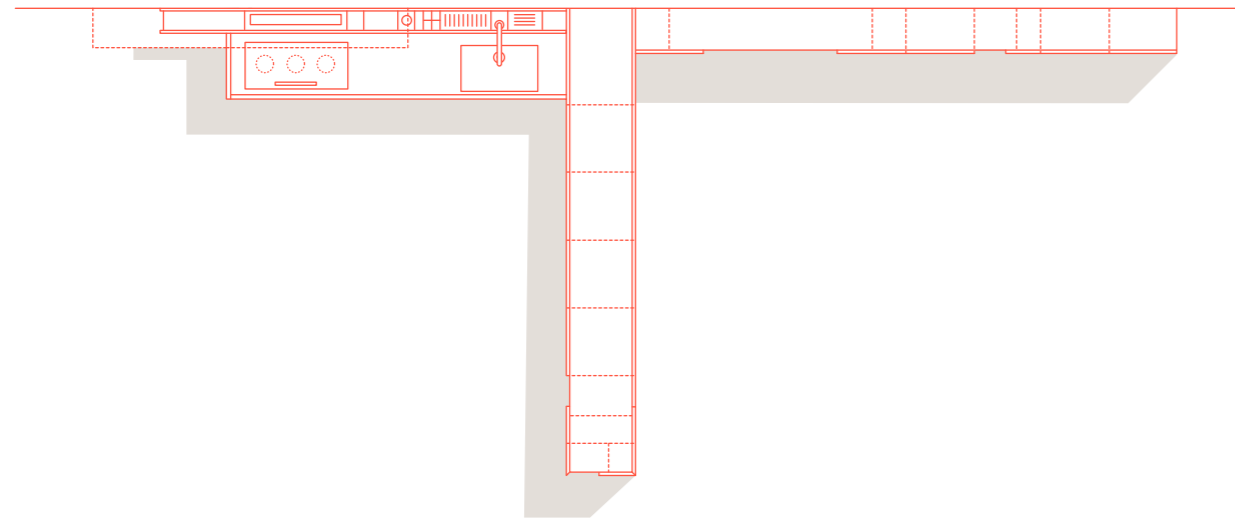





IT Una casa pensata per un abitare moderno che gioca su spazi fluidi, senza una netta divisione tra aree funzionali ma con una precisa connotazione dei singoli ambienti, dalla cucina al living all'home office.

EN A home that uses an interplay of fluid spaces, with no distinction between functional areas but with a specific trait for the different spaces, from the kitchen to the living room and to the home office, designed for a contemporary living.

FR Une maison conçue pour la vie moderne qui joue sur des espaces fluides, sans division claire entre les zones fonctionnelles mais avec une connotation précise des pièces individuelles, de la cuisine au séjour en passant par le bureau à domicile.

DE Ein Haus für modernes Wohnen, das mit fließenden Räumen spielt, ohne klare Trennung zwischen den Funktionsbereichen, aber mit einer bestimmten Kommunikation der einzelnen Räumen untereinander: von der Küche über das Wohnzimmer bis zum Home Office.

ES Una casa diseñada para la vida moderna que juega con los espacios fluidos, sin una división clara entre las áreas funcionales pero con una connotación precisa de las habitaciones individuales, desde la cocina hasta el salón y la oficina en casa.





# ME Trim

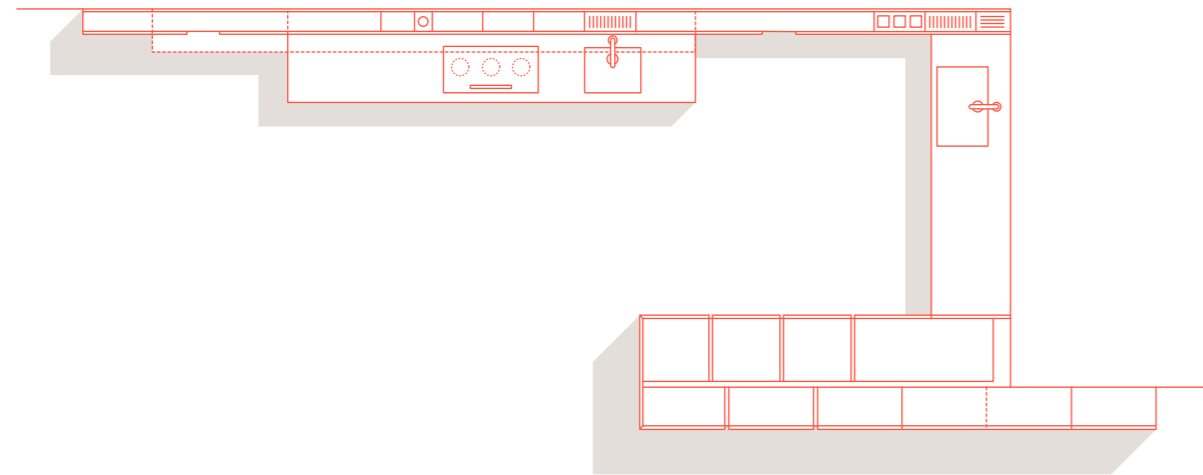

Acciaio BZ Ice /  
Laccato Opaco Ardesia /  
Essenza Premium Ossidiana /  
Laminato Plus Grigio Grafite



|   |   |  |  |   |
|---|---|--|--|---|
| <p>Acciaio BZ Ice /<br/>BZ Ice Steel /<br/>Acier BZ Ice /<br/>BZ Ice Stahl /<br/>Acero BZ Ice</p> | <p>Laccato Opaco Ardesia /<br/>Ardesia Matt Lacquer /<br/>Laqué mat Ardesia /<br/>Ardesia Matt Lackiert /<br/>Lacado Mate Ardesia</p> | <p>Essenza Premium Ossidiana /<br/>Ossidiana Premium Veneer /<br/>Plaqué Premium Ossidiana /<br/>Ossidiana Premium-Furnierholz /<br/>Contrachapado Premium Ossidiana</p> | <p>Essenza Premium Ossidiana /<br/>Ossidiana Premium Veneer /<br/>Plaqué Premium Ossidiana /<br/>Ossidiana Premium-Furnierholz /<br/>Contrachapado Premium Ossidiana</p> | <p>Laminato Plus Grigio Grafite /<br/>Grigio Grafite Plus Lamine /<br/>Stratifié Plus Grigio Grafite /<br/>Grigio Grafite Laminat Plus /<br/>Laminado Plus Grigio Grafite</p> |
|---|---|--|--|---|





<sup>IT</sup> Trim coniuga l'essenzialità e la leggerezza della nuova porta con struttura in alluminio con l'eleganza formale e l'effetto di sospensione tipico dell'apertura con gola. Il risultato è un sistema versatile, declinabile all'infinito.

<sup>EN</sup> Trim meets the essentiality and lightness of the new aluminum-honeycomb door with the formal elegance and suspension, typical of an opening with a handle-rail. The result is a versatile system that can be infinitely declined.

<sup>FR</sup> Trim combine l'essentialité et la légèreté de la nouvelle porte à cadre en aluminium avec l'élégance formelle et l'effet de suspension typique de l'ouverture à rainure. Le résultat est un système polyvalent qui peut être décliné à l'infini.

<sup>DE</sup> Trim verbindet die Wesentlichkeit und Leichtigkeit der neuen Tür mit Aluminiumrahmen mit der formalen Eleganz und dem Hängeeffekt, der für die Grifflosöffnung typisch ist. Das Ergebnis ist ein vielseitiges System, das unendlich dekliniert werden kann.

<sup>ES</sup> Trim combina la esencialidad y la ligereza de la nueva puerta con marco de aluminio con la elegancia formal y el efecto colgante típicos de la apertura de la gola. El resultado es un sistema versátil que se puede declinar al infinito.





# ME Trim

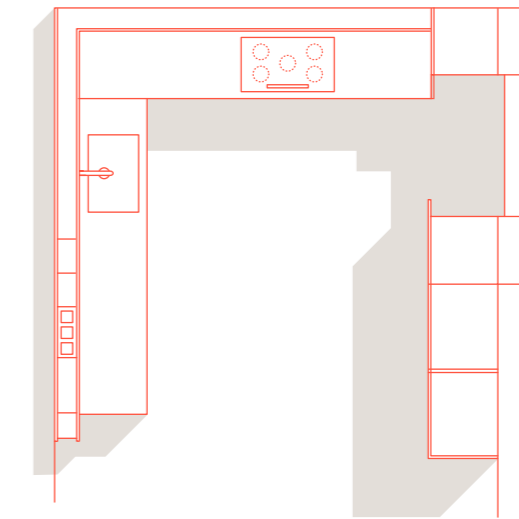

Laccato  
Opaco  
Artico



Laminam  
In-side  
Piasentina  
Grigia  
Fiammata



Fenix  
Bianco  
Kos



Essenza  
Premium  
Cenere



Laccato Opaco Artico /  
Artico Matt Lacquer /  
Laqué mat Artico /  
Artico Matt Lackiert /  
Lacado Mate Artico



Laminam In-side Piasentina  
Grigia Fiammata

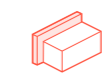

Fenix Bianco Kos



Essenza Premium Cenere /Cenere  
Premium Veneer /Plaqué Premium  
Cenere /  
Cenere Premium-Furnierholz /  
Contrachapado Premium Cenere



IT Una casa pensata per una famiglia, una cucina dalle dimensioni generose che si apre alla zona living pur mantenendo la propria identità grazie al Muretto attrezzato a due altezze che circonda e filtra la zona operativa.

EN A home designed around the family, a wider-sized kitchen spreads onto the living area while maintaining its own identity thanks to the double-height Muretto upright that delineates and filters the work area.

FR Une maison conçue pour une famille, une cuisine aux dimensions généreuses qui s'ouvre sur l'espace séjour tout en conservant sa propre identité grâce à l'élément Muretto équipé à deux hauteurs qui circonscrit et filtre la zone opérative.

DE Ein Haus für eine Familie, eine großzügige Küche, die sich zum Wohnbereich hin öffnet und gleichzeitig ihre eigene Identität bewahrt, dank des Element Muretto in zwei Höhen, das den Arbeitsbereich umschreibt und filtert.

ES Una vivienda pensada para una familia, una cocina de grandes dimensiones que se abre a la zona de estar conservando su propia identidad con el "Muretto" de doble altura que circunscribe y filtra la zona de trabajo.



# ME Murano

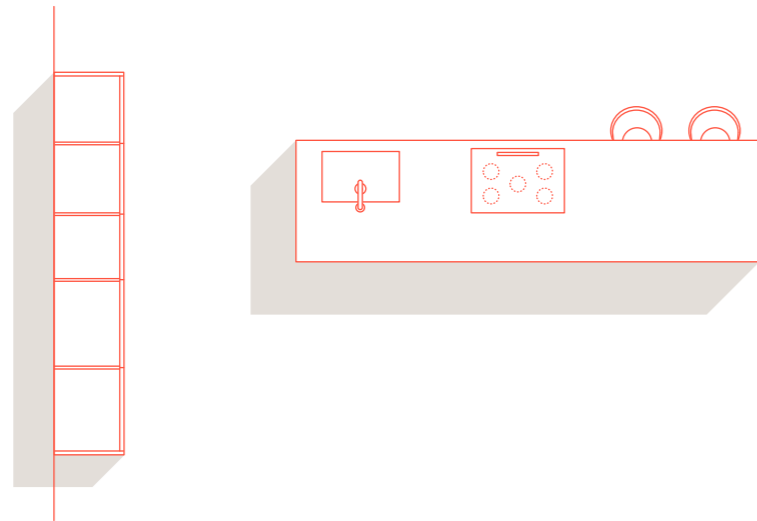

Vetro Acidato Nero / Vetro Lucido Nero / Olmo Lava



Vetro Acidato Nero / Nero Etched Glass / Verre Dépoli Nero / Nero Geätztes Glas / Cristal Mate Nero / Vetro Lucido Nero / Nero Gloss Glass / Verre Brillant Nero / Nero Hochglanz Glas / Cristal Brillo Nero / Olmo Lava / Olmo Lava Veneer / Plaqué Olmo Lava / Olmo Lava Furnierholz / Contrachapado Olmo Lava







<sup>IT</sup> Murano, una cucina in cui il vetro è assoluto protagonista: un materiale puro, versatile e inalterabile. Un'interpretazione tecnologica della materia nel segno della purezza e dell'eleganza.

<sup>EN</sup> Murano, a kitchen in which glass is the absolute protagonist: a pure, versatile and unalterable material. A technological interpretation of the material, all with purity and elegance.

<sup>FR</sup> Murano, une cuisine où le verre est le protagoniste absolu: un matériau pur, polyvalent et inaltérable. Une interprétation technologique du matériau sous le signe de la pureté et de l'élégance.

<sup>DE</sup> Murano, eine Küche in der Glas der absolute Protagonist ist: ein reines, vielseitiges und unveränderliches Material. Eine technologische Interpretation des Materials im Zeichen der Reinheit und Eleganz.

<sup>ES</sup> Murano, una cocina en la que el vidrio es el protagonista absoluto: un material puro, versátil e inalterable. Una interpretación tecnológica del material en el signo de la pureza y la elegancia.





# ME Materia

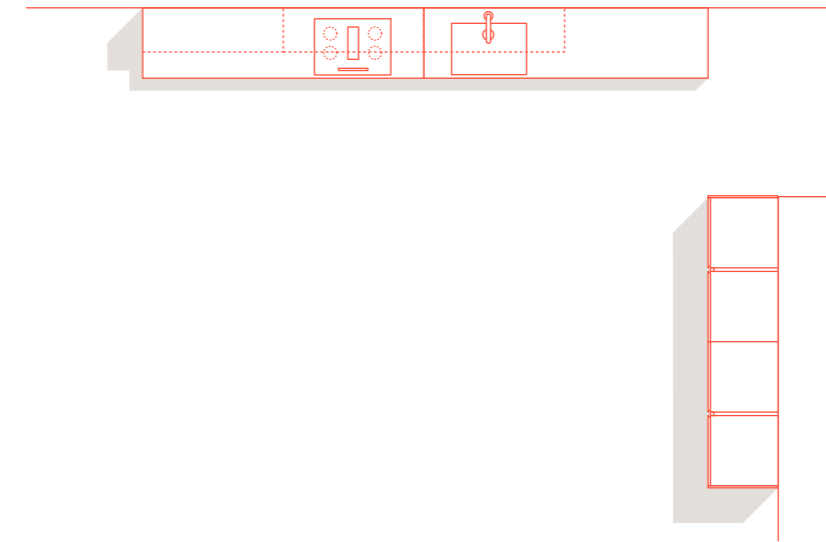

Laminam  
Pietra di  
Savoia  
Grigia  
Bocciardata



Brown

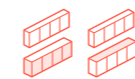

Laminam Pietra di Savoia  
Grigia Bocciardata



Laminam Pietra di Savoia  
Grigia Bocciardata



Crystal-Brown



<sup>IT</sup> Con Materia, architettura e tecnologia convivono in un'idea di casa nella quale la cucina può estendere i suoi elementi identificativi ad altri spazi più o meno contigui.

<sup>EN</sup> With Materia, architecture and technology coexist in the concept of a home in which the kitchen can extend its features and elements to other more or less contiguous spaces.

<sup>FR</sup> Avec Materia, architecture et technologie cohabitent dans une idée de maison dans laquelle la cuisine peut étendre ses éléments identitaires aux autres espaces plus ou moins contigus.

<sup>DE</sup> Mit Materia bestehen Architektur und Technologie nebeneinander in einer Idee vom Haus, in der die Küche ihre kennzeichnenden Elemente auf die mehr oder weniger angrenzenden Räume ausweiten kann.

<sup>ES</sup> Con Materia, arquitectura y tecnología conviven en una idea de hogar en la que la cocina puede extender sus elementos identificativos a otros espacios más o menos contiguos.

# ME Materia

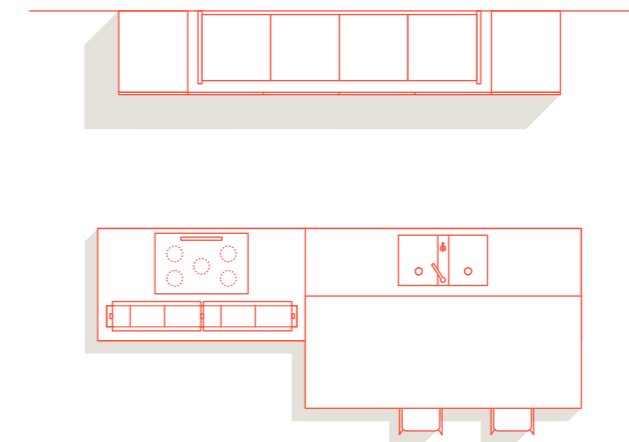

Corian  
Glacier  
White



Laccato  
Artico  
Opaco

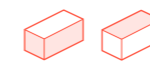

Corian Glacier White



Laccato Artico Opaco /  
Artico Matt Lacquer /  
Laqué mat Artico /  
Artico Matt Lackiert /  
Lacado Mate Artico



Corian Glacier White





IT Complete nelle dotazioni e capaci di interpretare spazi di ogni tipo, le cucine Materia si possono vestire con materiali in grado di cambiare da soli il carattere di un ambiente.



EN With complete equipment and capable of interpreting environments of all kinds, Materia kitchens can be dressed with materials capable of changing the identity of a space.

FR Complètes en équipements et capables d'interpréter des espaces de chaque type, les cuisines Materia peuvent être habillées de matériaux capables de changer le caractère d'une ambiance.

DE Komplet ausgestattet und in der Lage alle Räume einzurichten, kann Materia über die verschiedenen Materialien der Fronten den kompletten Charakter eines Raumes verändern.

ES Completamente equipadas y capaces de interpretar espacios de todo tipo, las cocinas Materia pueden vestirse con materiales que pueden cambiar por sí solos el carácter de una habitación.



# M2: Goccia Linea Crea Monoliti Memo

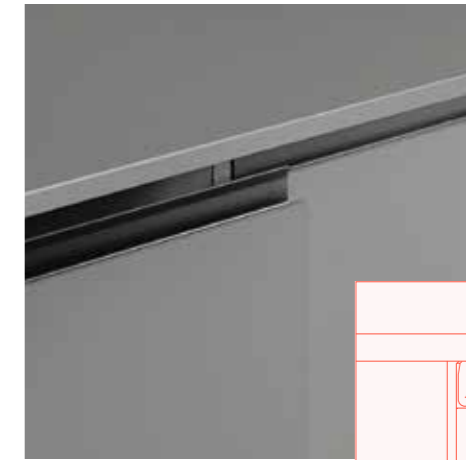
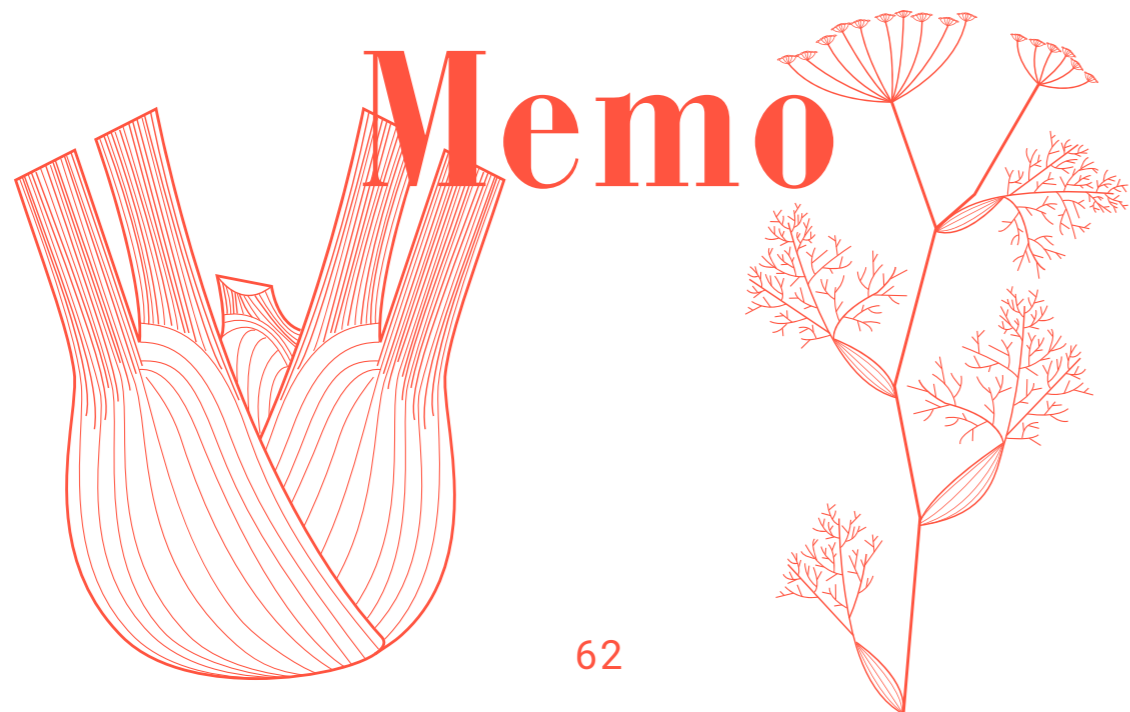

M2 Linea p.78

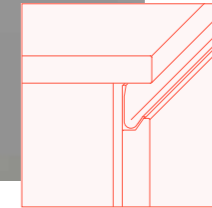

M2 Goccia p.64

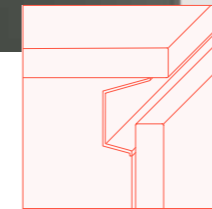

M2 Crea p.104



M2 Monoliti p.110

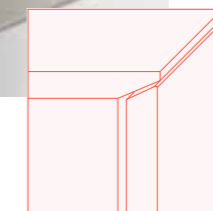

M2 Memo p.116

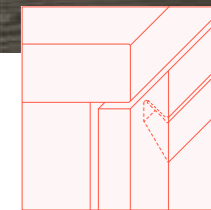

# M2 Goccia

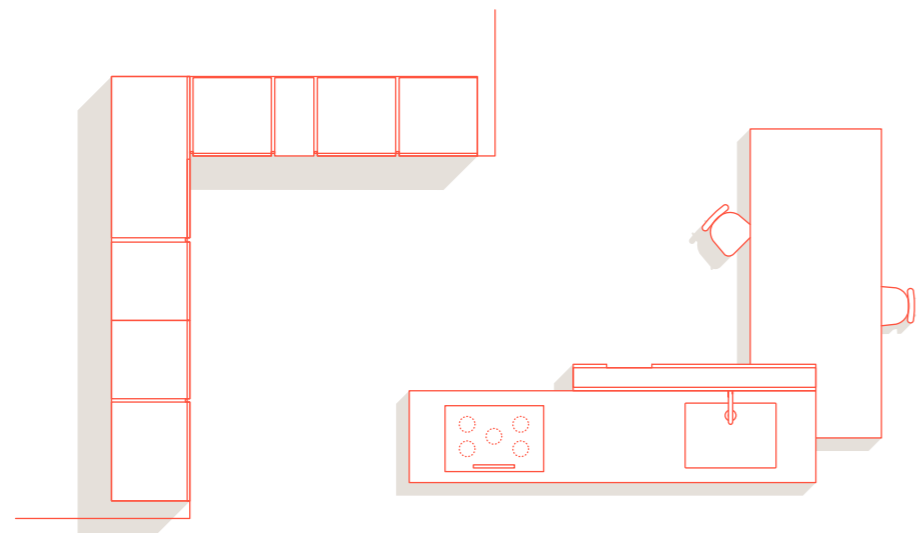

Fenix Verde Comodoro

Fenix Nero

Laccato Opaco Verde Salvia

Rovere Nodato Scuro

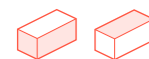

Fenix Verde Comodoro



Fenix Nero



Laccato Opaco Verde Salvia / Verde Salvia  
Matt Lacquer / Laqué Mat  
Verde Salvia / Verde Salvia  
Salvia Matt Lackiert / Lacado Mate Verde Salvia



Rovere Nodato Scuro /  
Rovere Nodato Scuro  
Veneer / Plaqué Rovere  
Nodato Scuro / Rovere  
Nodato Scuro Furnierholz  
/ Contrachapado Rovere  
Nodato Scuro



Rovere Nodato Scuro /  
Rovere Nodato Scuro  
Veneer / Plaqué Rovere  
Nodato Scuro / Rovere  
Nodato Scuro Furnierholz  
/ Contrachapado Rovere  
Nodato Scuro





IT Goccia interpreta l'ambiente cucina lasciando spazio alla libertà progettuale, per realizzare case capaci di assecondare i nostri bisogni.

EN Goccia gives to designers many tools, allowing this range to properly understand the kitchen environment, all with the goal to meet our needs.

FR Goccia interprète l'ambiance cuisine en laissant place à la liberté de conception, pour réaliser des maisons capables de répondre à nos besoins.

DE Goccia interpretiert das Umfeld der Küche und lässt Raum für Gestaltungsfreiheit, um Wohnungen zu schaffen, die unseren Bedürfnissen entsprechen.

ES Goccia interpreta el entorno de la cocina dejando espacio a la libertad de diseño, para crear hogares capaces de satisfacer nuestras necesidades.



# M2 Goccia

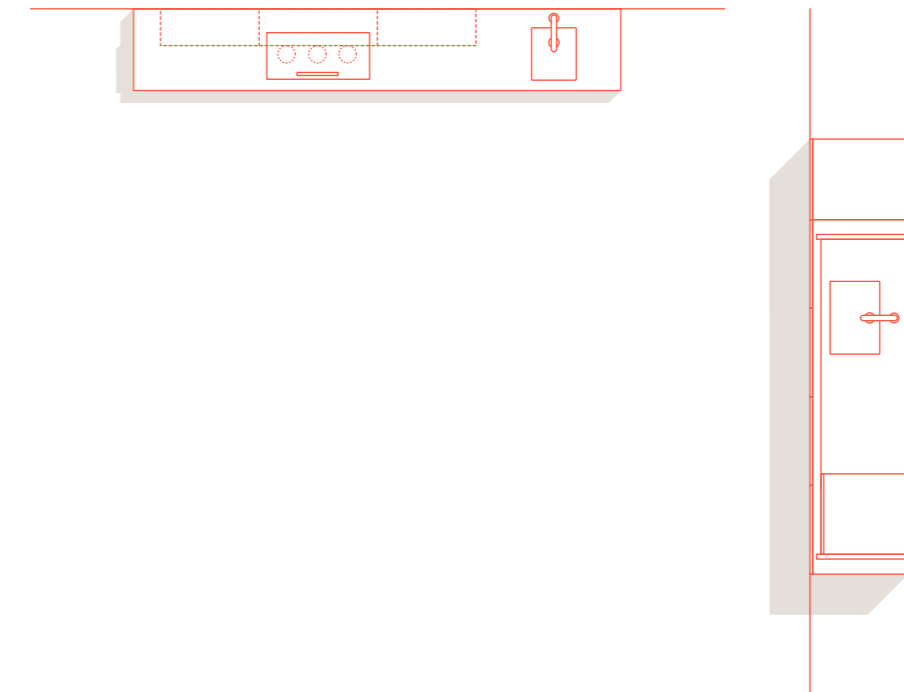

Fenix  
Blu Fes

Laccato  
Calce  
Zenzero

Acciaio  
BZ Ice



Fenix Blu Fes



Fenix Blu Fes



Laccato Calce Zenzero /  
Zenzero Calce Lacquer /  
Laqué Calce Zenzero /  
Zenzero Calce Lackiert /  
Lacado Calce Zenzero



Acciaio BZ Ice /  
BZ Ice Steel /  
Acier BZ Ice /  
BZ Ice Stahl /  
Acero BZ Ice /



IT La trasversalità di Goccia viene declinata nell'insieme di basi sospese e pensile ad anta unica, inseriti nel living come una composizione astratta, mentre il sistema C\_abina nasconde funzionalità da modulare in base alle proprie esigenze.

EN The versatility of Goccia is shown in the living room with an abstract design. This range slopes down within the set of suspended base units and single-door wall unit, while the Cabina system conceals functionality to be modulated according to one's needs.

FR La transversalité de Goccia se décline dans l'ensemble des meubles bas suspendus et du meuble haut à une porte, insérés dans le séjour comme une composition abstraite, tandis que le système C\_abina contient des fonctionnalités à moduler selon les besoins.

DE Die Flexibilität von Goccia zeigt sich in den Hängeunterschrank und der eintürigen Schrankwand, die sich als abstrakte Komposition in das Wohnzimmer einfügen, während das System C\_abina Funktionen verbirgt, die je nach Bedarf ausgestattet werden können.

ES La transversalidad de Goccia se declina en el conjunto de muebles bajos suspendidos con un mueble alto de una puerta, insertados en el salón como una composición abstracta, mientras que el sistema C\_abina esconde una funcionalidad que se puede modular según las necesidades.



# M2 Goccia

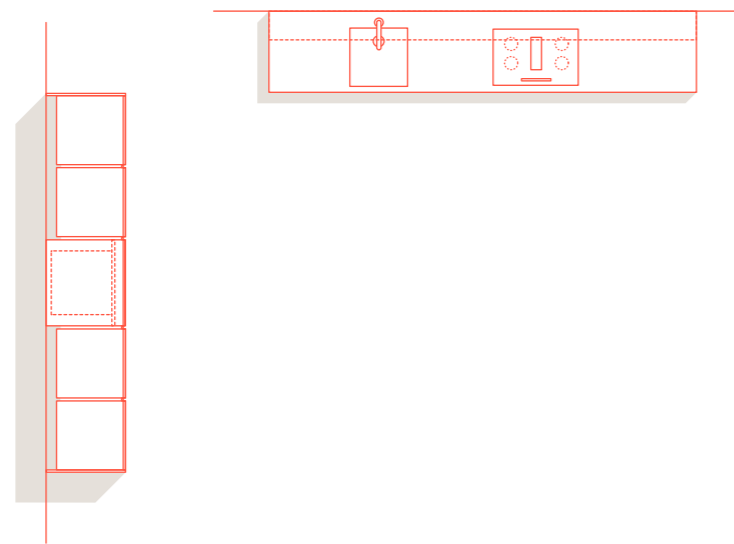

Rovere  
Termo  
trattato



Marmo  
Calacatta  
Vagli Oro



Laccato  
Opaco  
Brown



Rovere Termotrattato /  
Rovere Termotrattato  
Veneer / Plaqué Rovere  
Termotrattato / Rovere  
Termotrattato Furnierholz  
/ Contrachapado Rovere  
Termotrattato

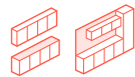

Marmo Calacatta Vagli Oro  
/ Calacatta Vagli Oro  
Marble / Marbre Calacatta  
Vagli Oro / Calacatta  
Vagli Oro Marmor / Mármol  
Calacatta Vagli Oro



Laccato Opaco Brown /  
Brown Matt Lacquer /  
Laqué Mat Brown /  
Brown Matt Lackiert /  
Lacado Mate Brown

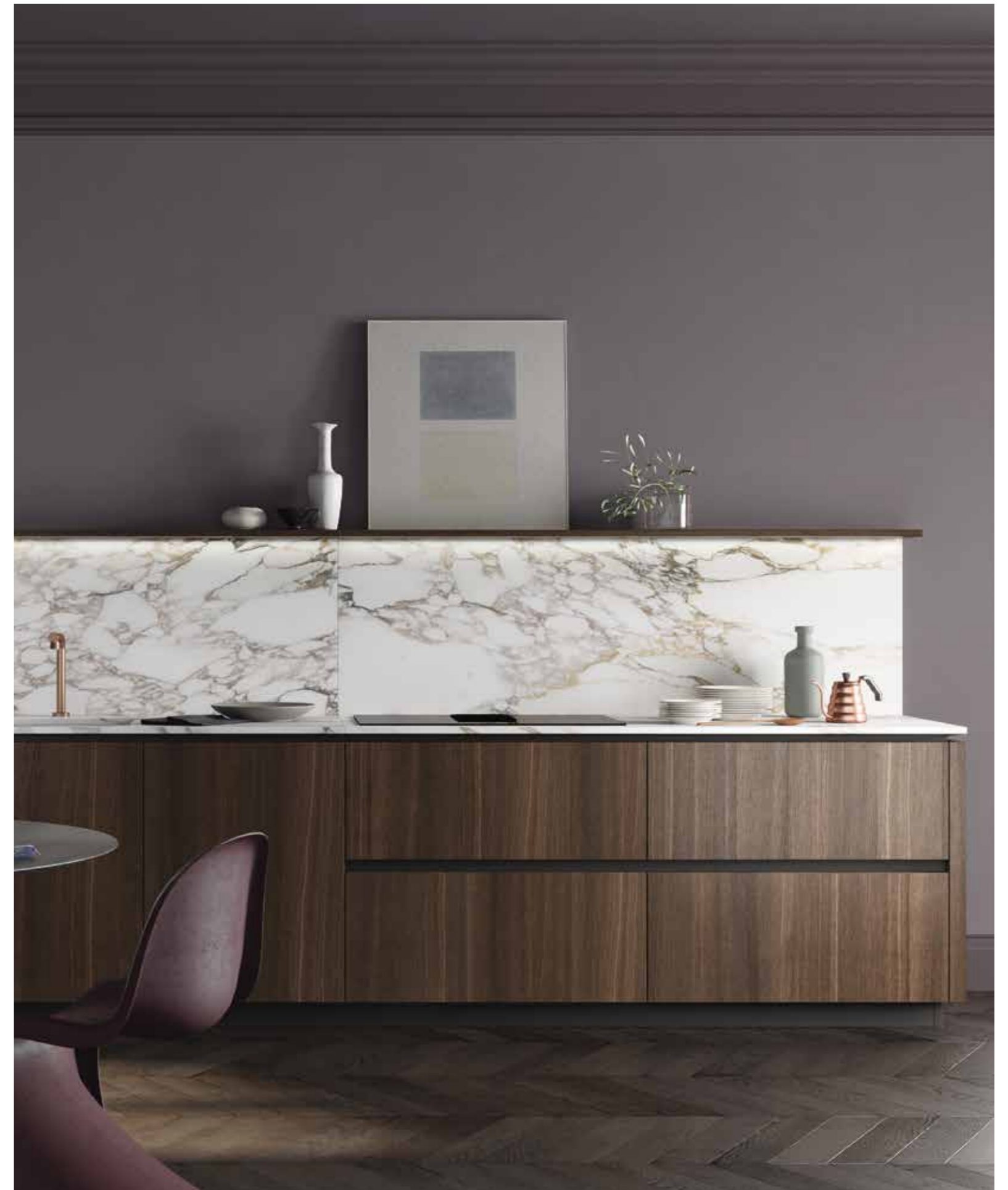



<sup>IT</sup> In un elegante appartamento di città, materiali dalle trame preziose e inattese nuance di colore creano un contesto di grande atmosfera.

<sup>EN</sup> In an elegant city apartment, materials with sophisticated textures and unexpected colours are combined to conjure up an atmospheric setting.

<sup>FR</sup> Dans un élégant appartement en ville, des matériaux aux textures précieuses et des nuances de couleurs inattendues créent un contexte de grande atmosphère.

<sup>DE</sup> In einer eleganten Stadtwohnung schaffen Materialien aus kostbaren Texturen und unerwartete Farbnuancen eine stimmungsvolle Atmosphäre.

<sup>ES</sup> En un elegante piso de ciudad, los materiales con texturas preciosas y matices de color inesperados crean un contexto de gran atmósfera.



# M2 Linea

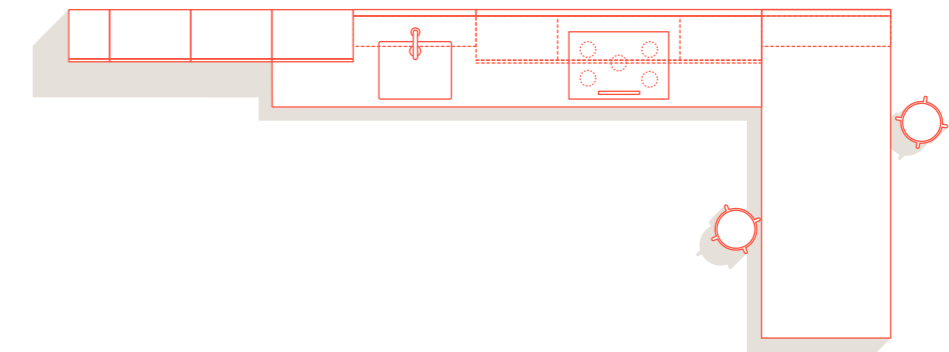

Fenix Grigio Antrim

Materico Plus Grigio Grafite

Materico Extra Mica Ferro

Materico Larice Nero

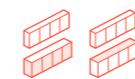

Fenix Grigio Antrim



Materico Plus Grigio Grafite / Grigio Grafite Plus Textured-melamine / Materico Plus Grigio Grafite / Grigio Grafite Plus Dekor / Materico Plus Grigio Grafite



Materico Plus Grigio Grafite / Grigio Grafite Plus Textured-melamine / Materico Plus Grigio Grafite / Grigio Grafite Plus Dekor / Materico Plus Grigio Grafite



Materico Extra Mica Ferro / Mica Ferro Extra Textured-melamine / Materico Extra Mica Ferro / Mica Ferro Extra Dekor / Materico Extra Mica Ferro



Materico Larice Nero / Larice Nero Textured-melamine / Materico Larice Nero / Larice Nero Dekor / Materico Larice Nero



IT Un locale industriale trasformato in appartamento e una cucina nella quale i toni di grigio delle ante si accostano sapientemente al nero dei profili.

EN An industrial space transformed into an apartment and a kitchen in which the unit doors in shades of grey are skilfully combined with the black of the profiles.

FR Un espace industriel transformé en appartement et une cuisine dans laquelle les tons de gris des portes se marient savamment avec le noir des profilés.

DE Eine zu einer Wohnung umgewandelte Industrietage und eine Küche, in der die Grautöne der Schranktüren sich elegant vom Schwarz der Profile absetzen.

ES Un espacio industrial transformado en un apartamento y una cocina en la que los tonos grises de las puertas se combinan hábilmente con el negro de los perfiles.



# M2 Linea

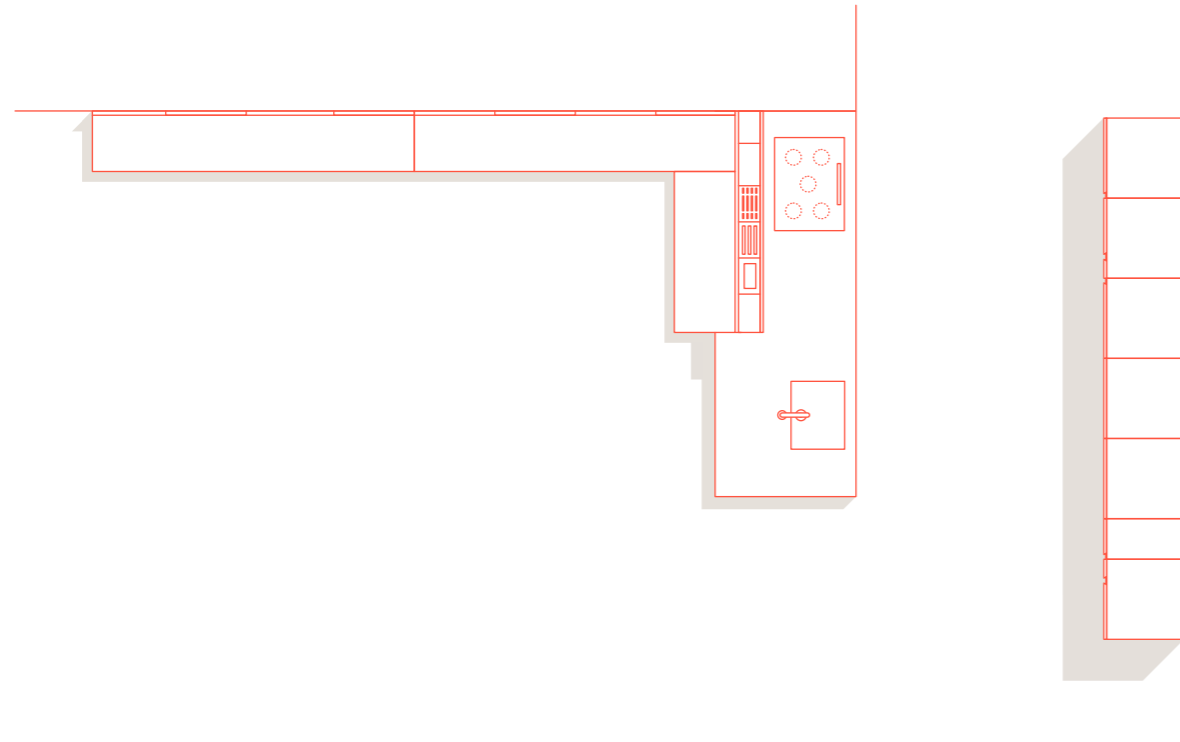

Laminato Omnia Kandia Bianco  
 Fenix Grigio Efeso  
 Fenix Bianco Kos

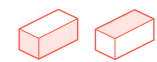

Laminato Omnia Kandia Bianco / Kandia Bianco Omnia Laminato / Stratifié Omnia Kandia Bianco / Kandia Bianco Omnia Laminat / Laminado Omnia Kandia Bianco

Fenix Grigio Efeso

Fenix Bianco Kos





IT Trasferiscono una sensazione di benessere le texture naturali di questo spazio cucina, progettato per la convivialità e completo di tutte le moderne funzionalità operative.

EN A sense of well-being is conveyed by the natural textures of this kitchen space, designed for socialising and fitted with all the modern conveniences.

FR Les textures naturelles de cet espace cuisine, conçu pour la convivialité et doté de toutes les fonctions opérationnelles modernes, transmettent une sensation de bien-être.

DE Die natürlichen Texturen dieses Küchenraums, der für ein geselliges Leben in der Küche gestaltet und mit allen modernen Funktionen ausgestattet wurde, vermitteln ein Gefühl des Wohlbehagens.

ES Las texturas naturales de este espacio de cocina, diseñado para la convivencia y dotado de todas las funciones operativas modernas, transmiten una sensación de bienestar.



# M2 Linea

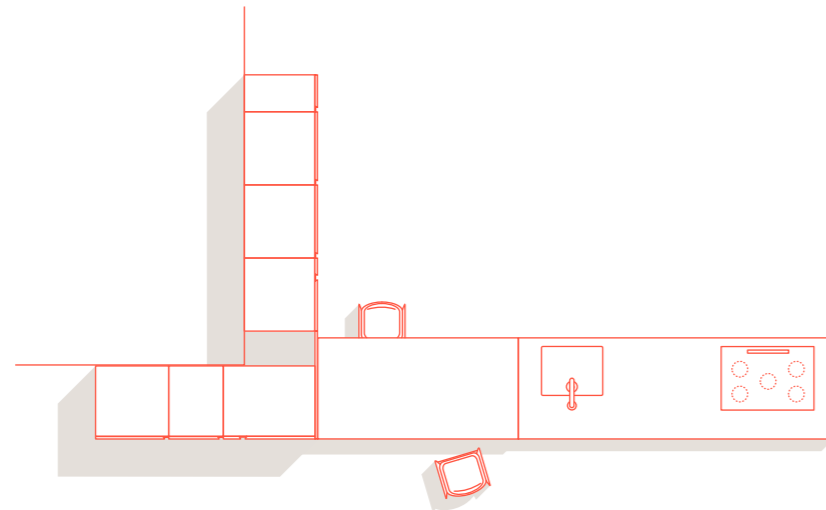

Fenix Grigio Bromo    Materico Extra Mica Lapis    Laminato Pietra Piasentina



|                    |  |   |
|--------------------|--|---|
| Fenix Grigio Bromo | Materico Extra Mica Lapis / Mica Lapis Extra<br>Textured melamine / Materico Extra Mica Lapis / Mica Lapis Extra Dekor / Materico Extra Mica Lapis | Laminato Pietra Piasentina / Pietra Piasentina Laminato / Stratifié Piasentina / Piasentina Laminat / Laminado Piasentina |
|--------------------|--|---|





IT La caratterizzazione creata dalle linee verticali e orizzontali della presa di apertura è il leitmotiv di una cucina ricca di spunti estetici e funzionali.

EN The signature feature created by the vertical and horizontal lines of the groove handles are the leitmotiv of a kitchen packed with visual appeal and practical touches.

FR La caractérisation créée par les lignes verticales et horizontales de la prise d'ouverture est le leitmotiv d'une cuisine riche en idées esthétiques et fonctionnelles.

DE Die von den vertikalen und horizontalen Linien der Griffe geschaffene Charakteristik ist das Leitmotiv einer Küche, die reich an ästhetischen und funktionalen Ideen ist.

ES La caracterización creada por las líneas verticales y horizontales de la toma de apertura es el leitmotiv de una cocina rica en ideas estéticas y funcionales.



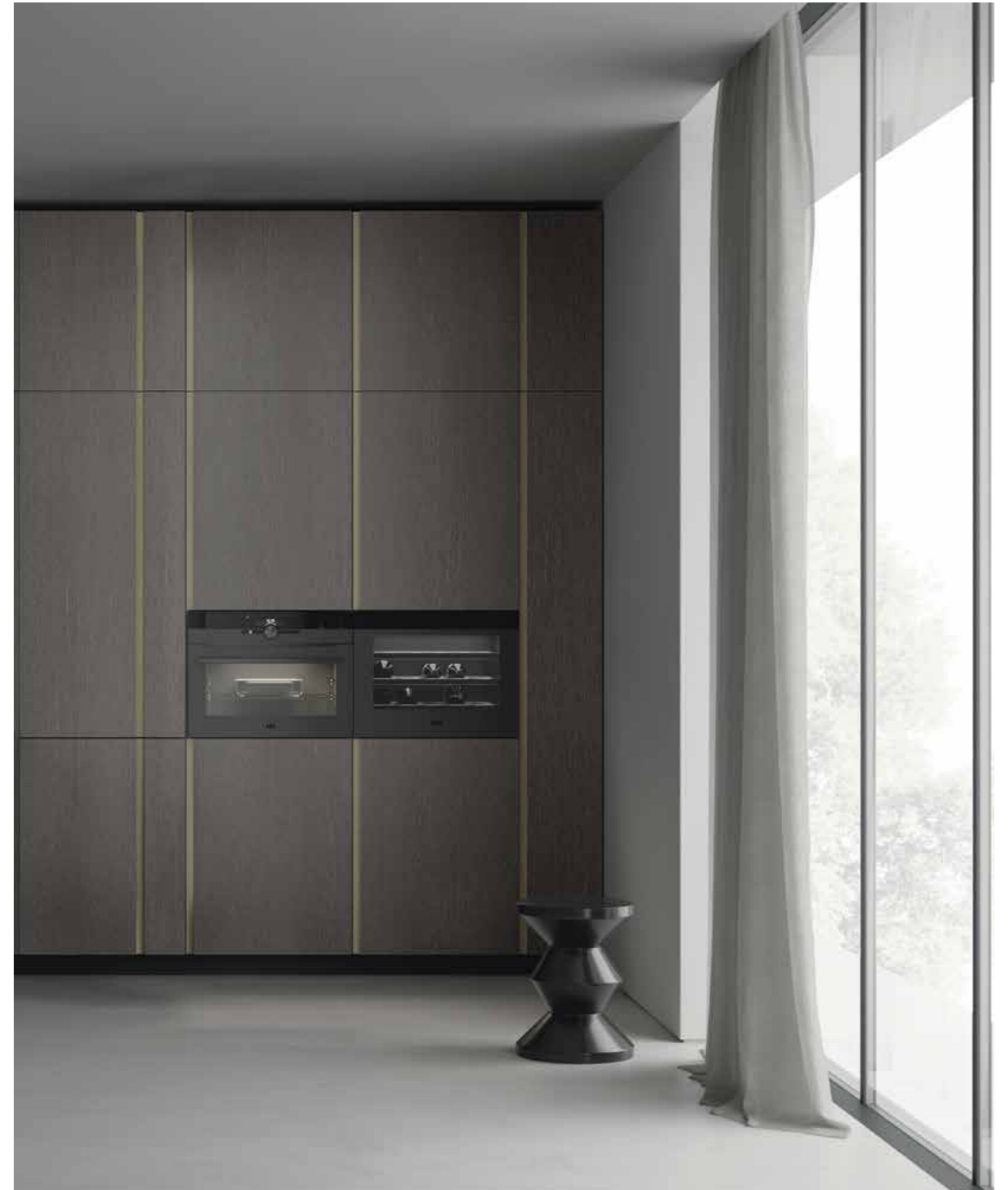

# M2 Linea

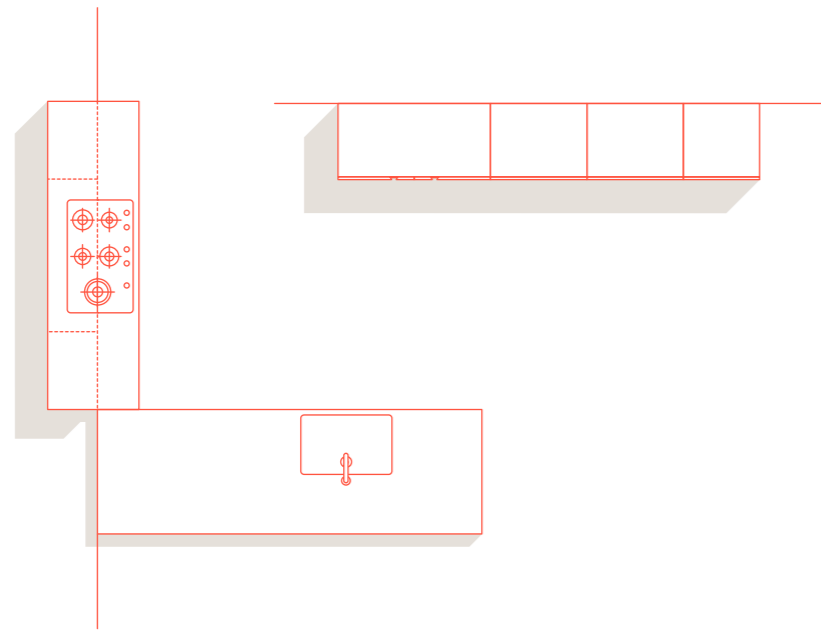

Laccato Tecc Bianco 72    Agglomerato Deluxe Serena Seta    Materico Extra Eucalipto Tabacco



|  |  |  |  |
|--|--|--|--|
| Laccato Tecc Bianco 72 / Bianco 72 Tecc Lacquer / Laqué Tecc Bianco 72 / Bianco 72 Tecc Lackiert / Lacado Tecc Bianco 72 | Laccato Tecc Bianco 72 / Bianco 72 Tecc Lacquer / Laqué Tecc Bianco 72 / Bianco 72 Tecc Lackiert / Lacado Tecc Bianco 72 | Agglomerato Deluxe Serena Seta / Serena Seta Deluxe Composite Stone / Agglomeré Deluxe Serena Seta / Serena Seta Deluxe Agglomerat / Aglomerado Deluxe Serena Seta | Materico Extra Eucalipto Tabacco / Eucalipto Tabacco Extra Textured-melamine / Materico Extra Eucalipto Tabacco Eucalipto Tabacco Extra Dekor / Materico Extra Eucalipto Tabacco |
|--|--|--|--|

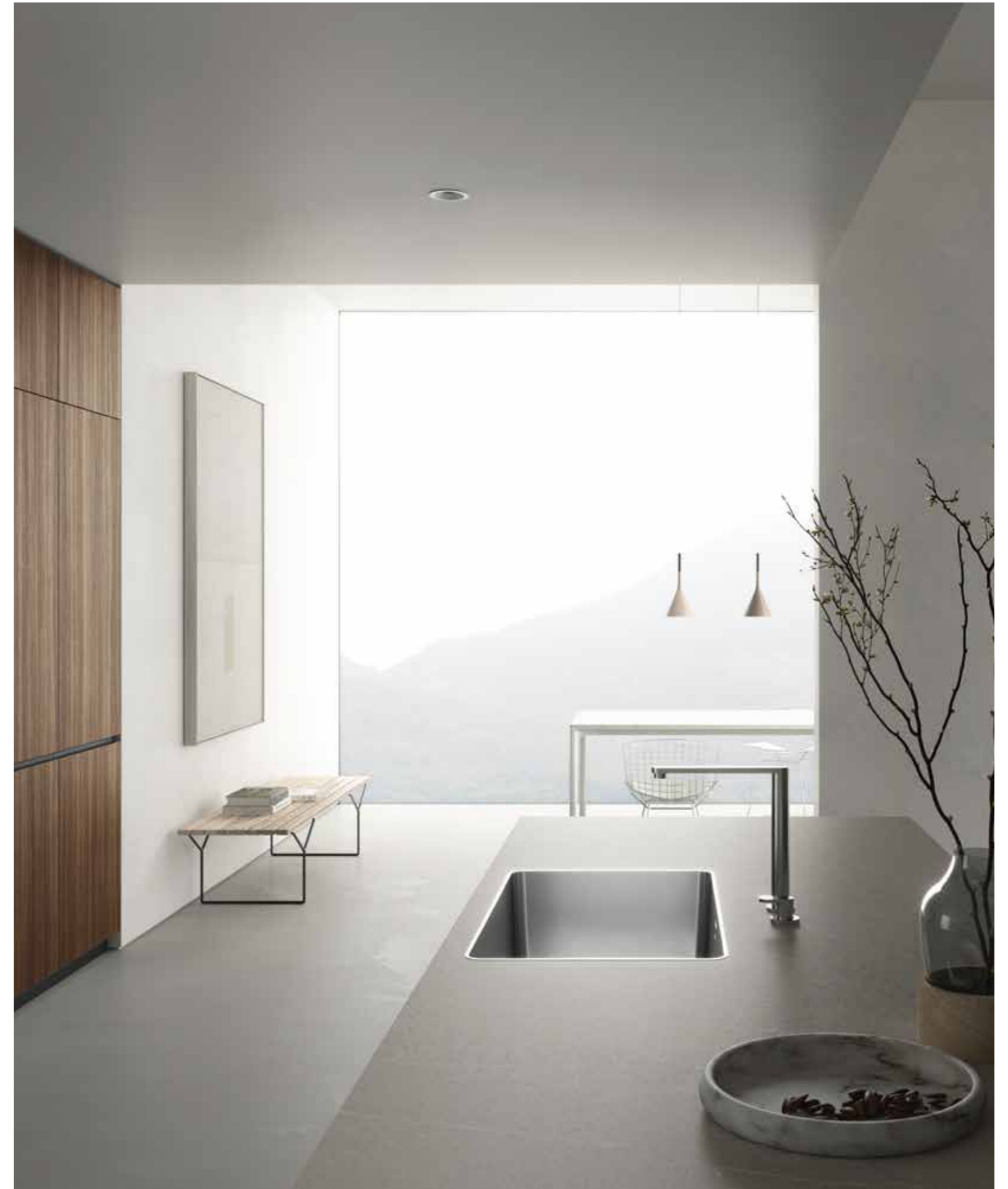



<sup>IT</sup> Ispirazioni scandinave per una cucina nella quale si coglie con immediatezza l'estrema pulizia delle linee e caratterizzata dall'inconfondibile design del profilo di apertura di Linea.

<sup>EN</sup> Scandinavian inspirations for a kitchen in which the extreme cleanliness of the lines is immediately apparent and which is characterized by the unmistakable design of the Linea opening profile.

<sup>FR</sup> Des inspirations scandinaves pour une cuisine dont l'extrême pureté des lignes est immédiatement perceptible et qui se caractérise par le design inimitable du profil d'ouverture Linea.

<sup>DE</sup> Skandinavische Inspirationen für eine Küche, bei der die extreme Sauberkeit der Linien sofort ins Auge fällt und die durch das unverwechselbare Design des Linea Öffnungsprofils gekennzeichnet ist.

<sup>ES</sup> Inspiraciones escandinavas para una cocina en la que la extrema limpieza de las líneas es inmediatamente evidente y que se caracteriza por el inconfundible diseño del perfil de apertura Linea.





# M2 Crea

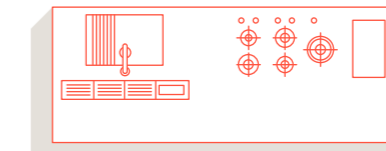
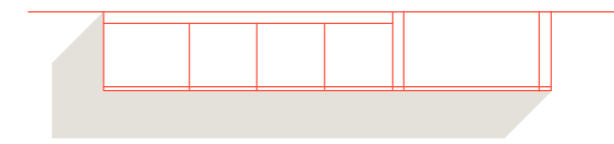

Fenix Nero



Acciaio Satinato



Olmo Lava



Laccato Opaco Nero



Fenix Nero



Acciaio Satinato /  
Satin Steel /  
Acier Brossé /  
Satin Stahl /  
Acero Satinado



Olmo Lava /  
Olmo Lava Veneer /  
Plaqué Olmo Lava /  
Olmo Lava Furnierholz /  
Contrachapado Olmo Lava



Laccato Opaco Nero /  
Nero Matt Lacquer /  
Laqué Mat Nero /  
Nero Matt Lackiert /  
Lacado Mate Nero



<sup>IT</sup> Le maniglie Max, la leggerezza della cappa sospesa e la completezza di dotazioni tecnologiche in una cucina del sistema M2 che invita a condividere il piacere della buona tavola.

<sup>EN</sup> The Max handles, the lightness of the suspended hood and comprehensive technological fittings in an M2 kitchen system is an invitation to share in the pleasure of good food.

<sup>FR</sup> Les poignées Max, la légèreté de la hotte suspendue et la complétude des équipements technologiques dans une cuisine du système M2 qui invite à partager le plaisir de la bonne table.

<sup>DE</sup> Die Handgriffe Max, die Leichtigkeit der aufgehängten Haube und die Vollständigkeit der technologischen Ausrüstungen in einer Küche des Systems M2, die dazu einlädt, die Freude am guten Essen zu teilen.

<sup>ES</sup> Los tiradores Max, la ligereza de la campana suspendida y lo completo del equipamiento tecnológico en una cocina del sistema M2 que invita a compartir el placer de la buena mesa.





# M2 Monoliti

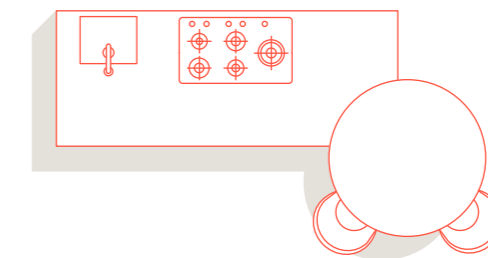
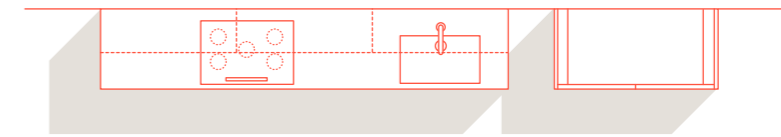

Fenix Bianco

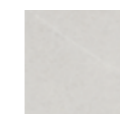

Laminato Omnia Kandia Bianco



Olmo Sbiancato



Fenix Bianco



Laminato Omnia Kandia Bianco / Kandia Bianco Omnia Laminato / Stratifié Omnia Kandia Bianco / Kandia Bianco Omnia Laminat / Laminado Omnia Kandia Bianco



Olmo Sbiancato / Olmo Sbiancato Veneer / Plaqué Olmo Sbiancato / Olmo Sbiancato Furnierholz / Contrachapado Olmo Sbiancato



<sup>IT</sup> Un progetto nel quale la pulizia dell'insieme lascia emergere l'accuratezza costruttiva e l'impronta estetica di materiali e finiture, tipica del modello Monoliti.

<sup>EN</sup> A project in which the clean lines of the overall design show the meticulous workmanship and aesthetic appeal of the materials and finishings, typical of the Monoliti model.

<sup>FR</sup> Un projet où la propreté de l'ensemble révèle la précision constructive et l'empreinte esthétique des matériaux et des finitions, typiques du modèle Monoliti.

<sup>DE</sup> Ein Entwurf, bei dem aus der Reinheit des Ganzen die ganze Baupräzision und ästhetische Wirkung der Materialien und Oberfläche zutage kommen, die für das Modell Monoliti typisch sind, offenbart.

<sup>ES</sup> Un diseño en el que la limpieza del conjunto revela la precisión constructiva y la impronta estética de los materiales y los acabados, típica del modelo Monoliti.



# M2 Memo

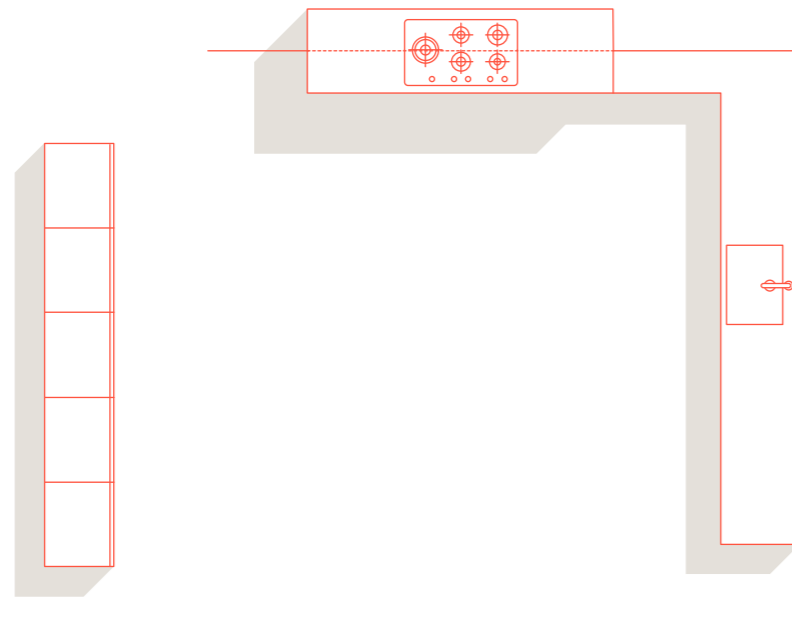

Olmo Grigio  
Laminam Pietra di Savoia Grigia Bocciardata  
Laccato Opaco Efeso FX



Olmo Grigio\_Profilo  
Titanio / Olmo Grigio  
Veneer\_Titanio Profile /  
Plaqué Olmo Grigio\_  
Titanio Profil / Olmo  
Grigio Furnierholz\_  
Titanio Türprofil /  
Contrachapado Olmo  
Grigio\_Titanio Perfil

Laminam Pietra di Savoia  
Grigia Bocciardata

Laccato Opaco Efeso FX /  
Efeso FX Matt Lacquer /  
Laqué mat Efeso FX /  
Efeso FX Matt Lackiert /  
Lacado Mate Efeso FX

Laccato Opaco Efeso FX /  
Efeso FX Matt Lacquer /  
Laqué mat Efeso FX /  
Efeso FX Matt Lackiert /  
Lacado Opaco Efeso FX

Olmo Grigio\_Profilo  
Titanio / Olmo Grigio  
Veneer\_Titanio Profile /  
Plaqué Olmo Grigio\_  
Titanio Profil / Olmo  
Grigio Furnierholz\_  
Titanio Türprofil /  
Contrachapado Olmo  
Grigio\_Titanio Perfil





IT Memo recupera i valori della cucina tradizionale in legno aggiornandone i contenuti tecnologici. Essenze pregiate, lavorate con attenzione da mani sapienti, conferiscono ad ogni componente un carattere unico.

EN Memo recalls the value of a solid timber kitchen by refurbishing its technological content. Precious woods, carefully worked by skilled hands, give each component a unique character.

FR Memo rappelle les valeurs de la cuisine en bois en actualisant son contenu technologique. Des bois précieux, soigneusement travaillés par des mains habiles, donnent à chaque élément un caractère unique.

DE Memo erinnert an die Werte der Holzküche, indem es den technologischen Inhalt aktualisiert. Edle Hölzer, sorgfältig bearbeitet werden, verleihen jedem Teil einen einzigartigen Charakter.

ES Memo recuerda los valores de la cocina de madera actualizando su contenido tecnológico. Las maderas de calidad, cuidadosamente trabajadas por manos expertas, dan a cada componente un carácter único.



# M6: Vela Presa Profili



M6 Vela p.124

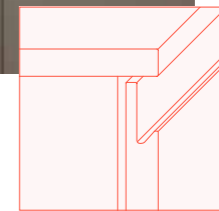

M6 Profili p.134

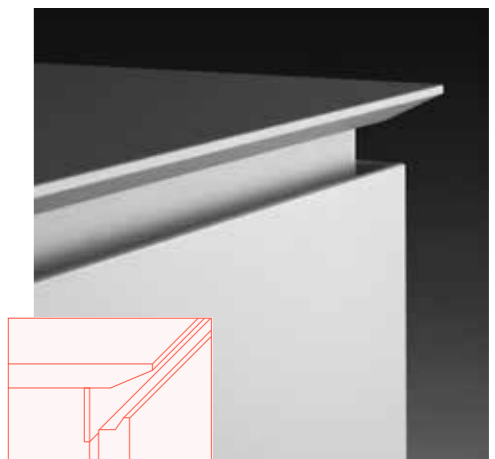
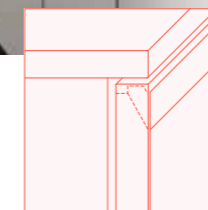

M6 Presa p.130

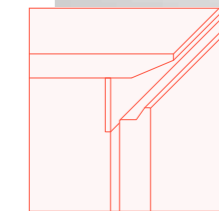

# M6 Vela

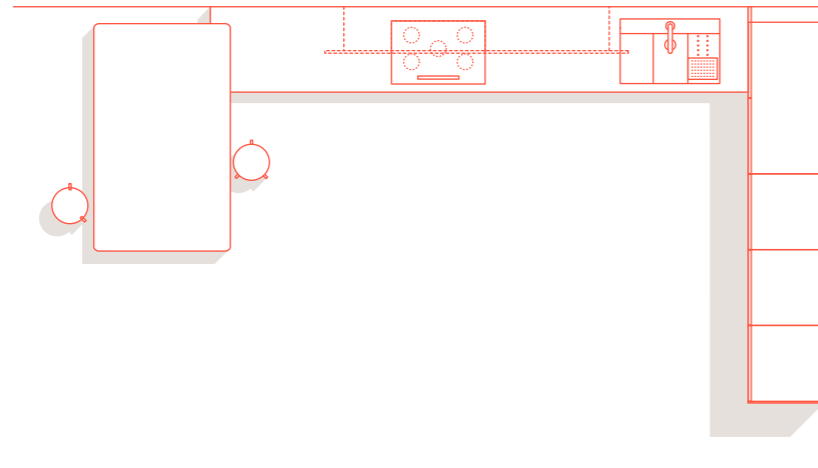

Laccato  
Lucido  
Visone



Acciaio  
Satinato



Laccato  
Opaco  
Terranova



Rovere  
Termotrattato



Laccato Lucido Visone /  
Visone Gloss Lacquer /  
Laqué Brillant Visone /  
Visone Glänzend Lackiert /  
Lacado Brillo Visone



Acciaio Satinato /  
Satin Steel /  
Acier Brossé /  
Satin Stahl /  
Acero Satinado



Laccato Opaco Terranova /  
Terranova Matt Lacquer /  
Laqué mat Terranova /  
Terranova Matt Lackiert /  
Lacado Mate Terranova



Laccato Opaco Terranova /  
Terranova Matt Lacquer /  
Laqué mat Terranova /  
Terranova Matt Lackiert /  
Lacado Mate Terranova



Rovere Termotrattato /  
Rovere Termotrattato  
Veneer / Plaqué Rovere  
Termotrattato / Rovere  
Termotrattato Furnierholz /  
Contrachapado Rovere  
Termotrattato

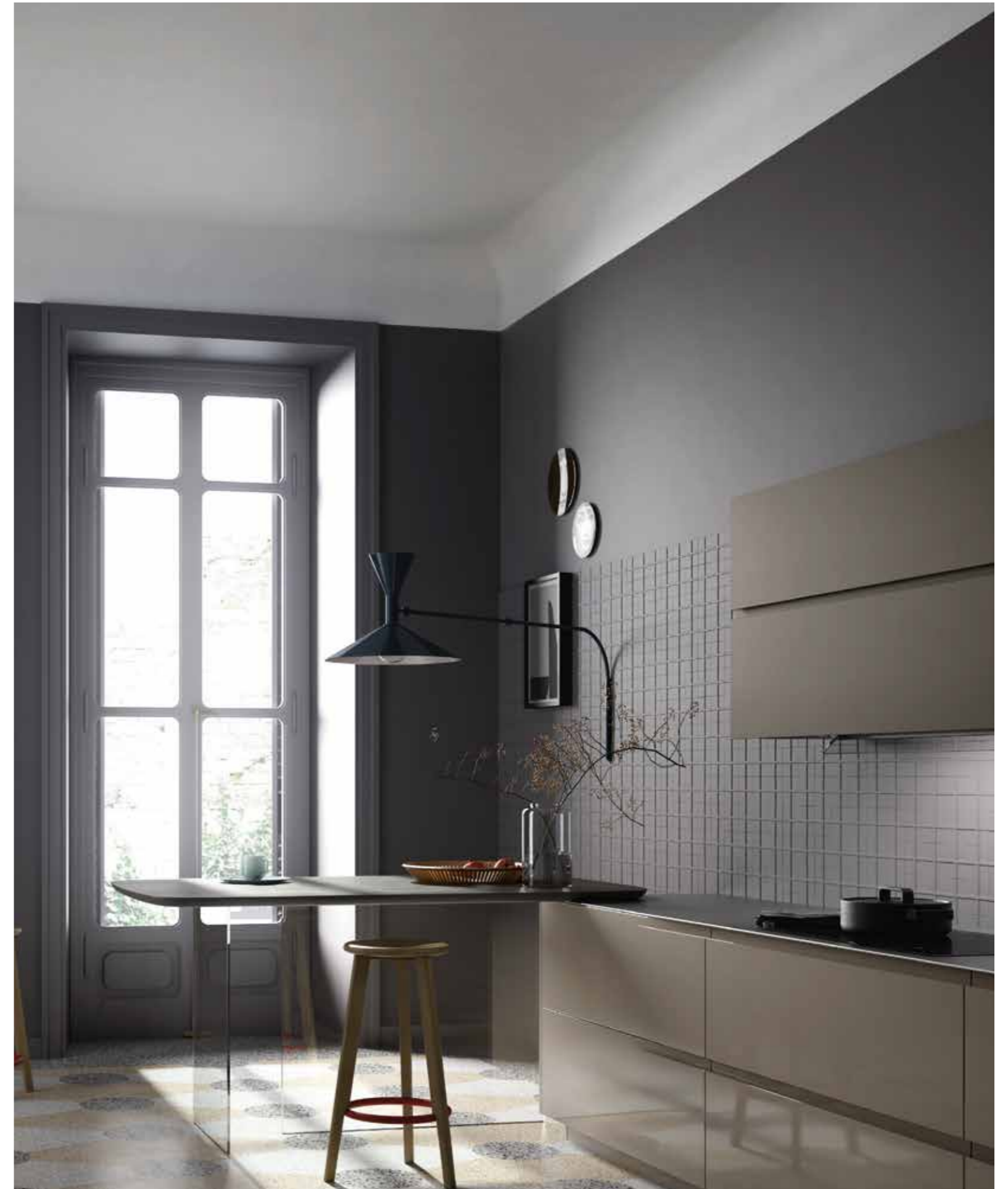





<sup>IT</sup> La personalità di Vela entra in una dimora storica vestendo i toni raffinati dei laccati lucidi e opachi che esaltano la caratteristica anta scolpita.

<sup>EN</sup> The personality of Vela is introduced into a historical home through the sophisticated shades of gloss and matt lacquers that enhance the distinctive carved door

<sup>FR</sup> La personnalité de Vela entre dans une maison historique avec les tons raffinés des laques brillantes et mates qui mettent en valeur la porte sculptée caractéristique.

<sup>DE</sup> Die Personalität von Vela nimmt einen historischen Wohnsitz in Besitz und kleidet ihn in die raffinierten Töne der glänzenden und matten Lacke, die die charakteristisch geschnitzte Tür hervorheben.

<sup>ES</sup> La personalidad de Vela entra en una residencia histórica vistiéndolo los refinados tonos de los lacados brillantes y mates que realzan la característica puerta tallada.



# M6 Presa

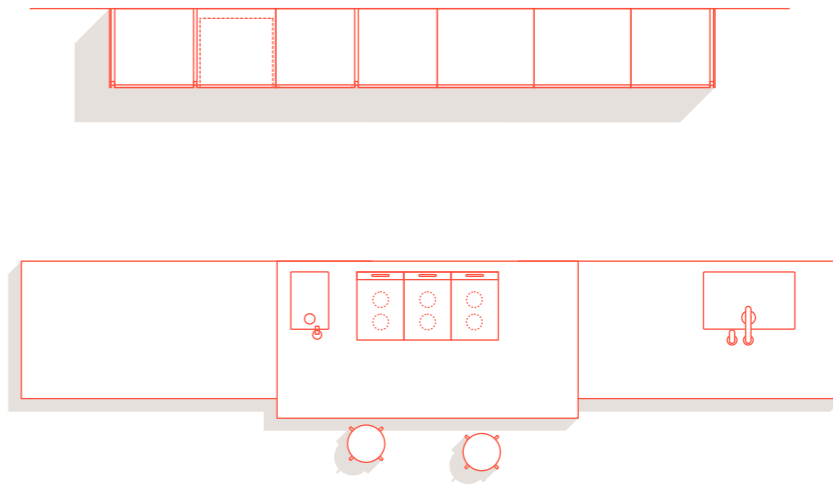

Laccato Opaco Artico



Corian Glacier White



Laccato Opaco Brown



Agglomerato Deluxe Serena Seta



Laccato Opaco Artico / Artico Matt Lacquer / Laqué mat Artico / Artico Matt Lackiert / Lacado Opaco Artico



Corian Glacier White



Laccato Opaco Brown / Brown Matt Lacquer / Laqué mat Brown / Brown Matt Lackiert / Lacado Mate Brown



Agglomerato Deluxe Serena Seta / Serena Seta Deluxe Composite Stone / Agglomeré Deluxe Serena Seta / Serena Seta Deluxe Agglomerat / Agglomerado Deluxe Serena Seta



<sup>IT</sup> Nel concept di Presa, tecnica e bellezza sono elementi comuni di un progetto che arriva all'essenza del design attraverso la ricerca dell'armonia.

<sup>EN</sup> In the concept of Presa, technique and beauty are the common elements of a project that showcases the essence of the design through the search for balance.

<sup>FR</sup> Dans le concept de Presa, la technique et la beauté sont des éléments communs d'un projet qui atteint l'essence du design à travers la recherche de l'harmonie.

<sup>DE</sup> Beim Konzept Presa sind die Technik und die Schönheit die gemeinsamen Elemente eines Projekts, das die Essenz des Design über die Suche nach Harmonie erreicht.

<sup>ES</sup> En el concepto Presa, la técnica y la belleza son elementos comunes de un proyecto que alcanza la esencia del diseño a través de la búsqueda de la armonía.

# M6 Profili

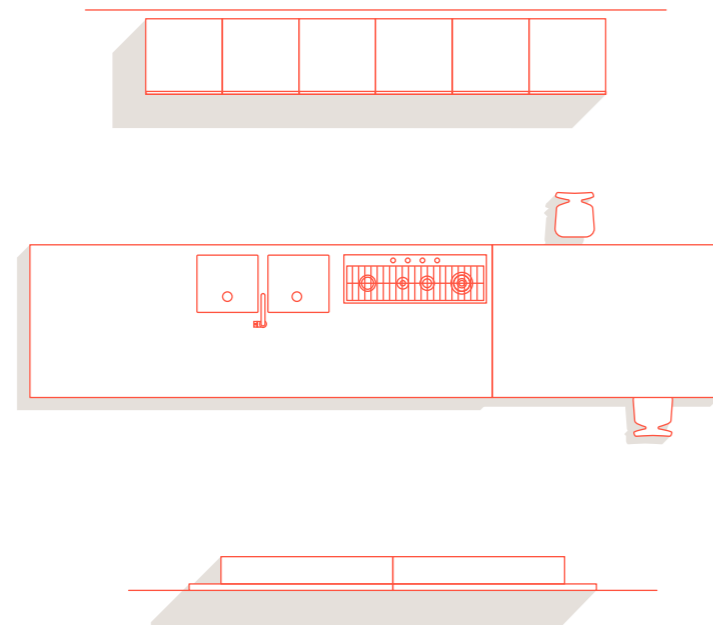

Laccato  
Lucido  
Artico

Agglomerato  
Deluxe  
Concrete  
Grigio

Essenza  
Noce  
Tecnico



Laccato Lucido Artico\_  
profilo Brunito / Artico  
Gloss Lacquer\_Brunito  
profile / Laqué brillant  
Artico\_Brunito profil /  
Artico Glänzend Lackiert\_  
Brunito Türprofil / Lacado  
Brillo Artico\_Brunito  
perfil

Agglomerato Deluxe  
Concrete Grigio / Concrete  
Grigio Deluxe Composite  
Stone / Agglomeré Deluxe  
Concrete Grigio Seta /  
Concrete Grigio Seta  
Deluxe Agglomerat /  
Agglomerato Deluxe Concrete  
Grigio Seta

Essenza Noce Tecnico /  
Noce Tecnico Vener /  
Plaqué Noce Tecnico /  
Noce Tecnico Furnierholz /  
Contrachapado Noce  
Tecnico

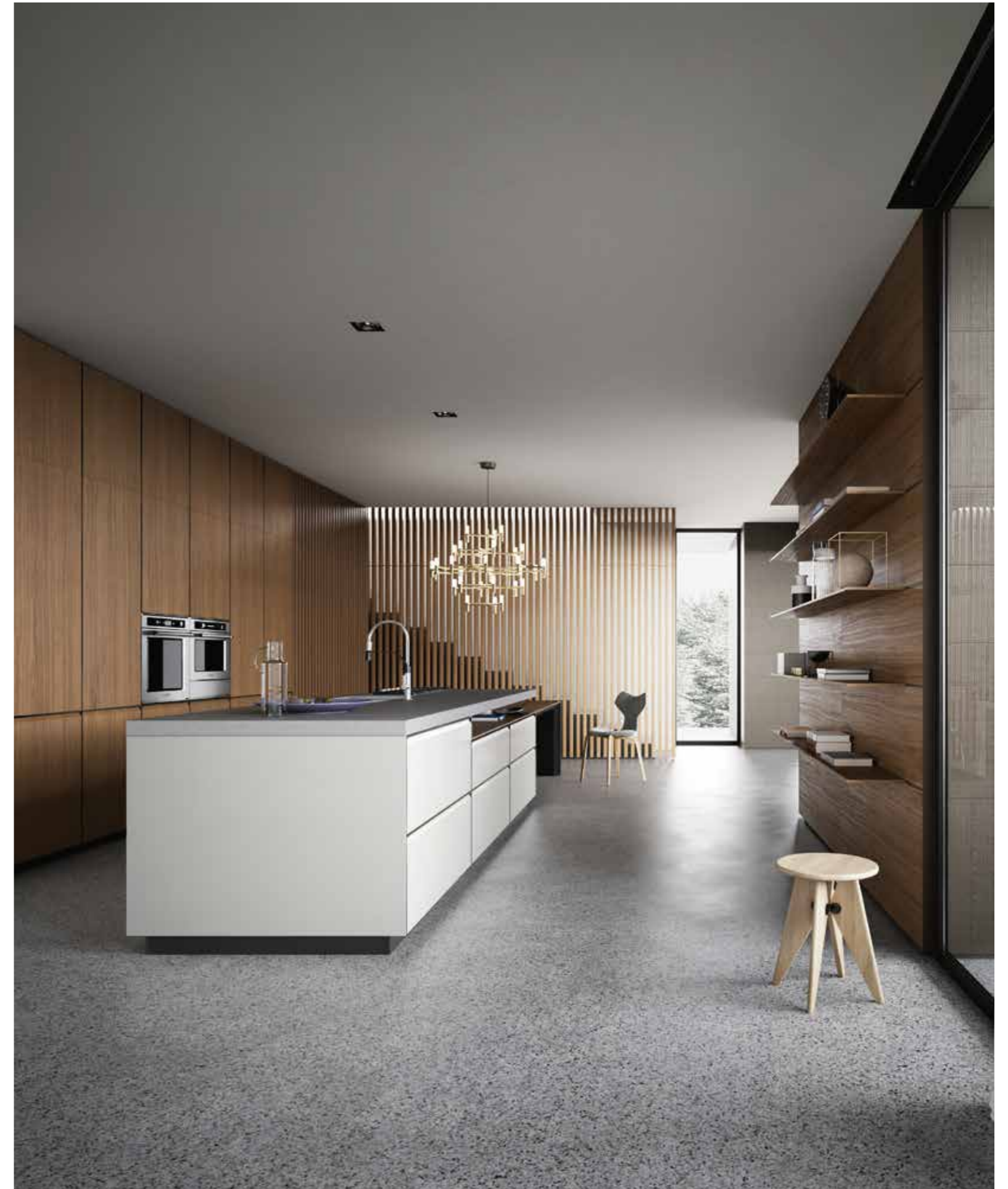



IT Il profilo in metallo che protegge e delimita l'anta su tre lati è il tratto distintivo di questo modello. Una caratteristica che lascia spazio a molteplici combinazioni estetiche.

EN The metal profile which protects and frames the door on three sides is the signature feature of this model. A feature which leaves room for numerous aesthetic combinations.

FR Le profilé métallique qui protège et délimite la porte sur trois côtés est la particularité de ce modèle. Une caractéristique qui laisse espace à de multiples combinaisons esthétiques.

DE Das Metallprofil, das die Tür auf drei Seiten schützt und einfasst, ist der unterscheidende Wesenszug dieses Modells. Eine Charakteristik, die eine Vielzahl an ästhetischen Kombinationen schafft.

ES El perfil metálico que protege y delimita la puerta por tres lados es el rasgo distintivo de este modelo. Una característica que deja espacio para múltiples combinaciones estéticas.

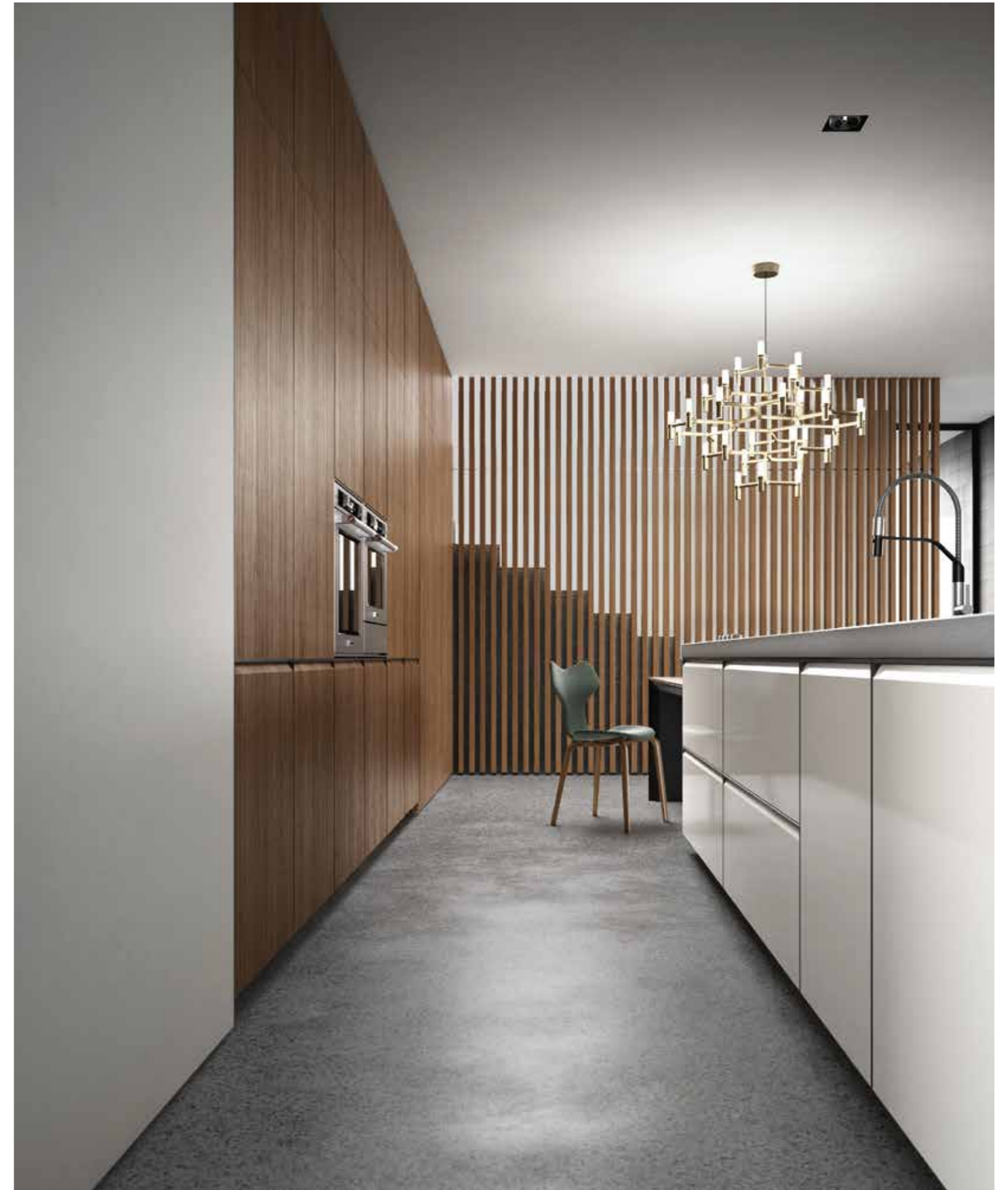

**Questa sezione è un invito a configurare la vostra cucina Meson's con una gamma di materiali dalle eccezionali caratteristiche di qualità e resistenza. Ciascuno proposto in una palette di toni accuratamente selezionata per vestire i volumi della vostra cucina con un carattere e una personalità inconfondibili.**

<sup>EN</sup> This section is an invitation to configure your Meson's kitchen with a range of materials of exceptional quality and resilience. Each is proposed in a carefully selected range of colours to dress the volumes of your kitchen with unmistakable character and personality.

<sup>FR</sup> Cette section est une invitation à configurer votre cuisine Meson's avec une gamme de matériaux de qualité et de durabilité exceptionnelles. Chacun est proposé dans une palette de tons soigneusement sélectionnés pour habiller les volumes de votre cuisine avec un caractère et une personnalité incomparables.

<sup>DE</sup> Dieser Abschnitt ist eine Einladung, Ihre Meson's-Küche mit einer Reihe von Materialien von außergewöhnlicher Qualität und Haltbarkeit zu konfigurieren. Jedes wird in einer sorgfältig ausgewählten Palette von Farbtönen angeboten, um die Volumen Ihrer Küche mit unverwechselbarem Charakter und Persönlichkeit zu versehen.

<sup>ES</sup> Esta sección es una invitación a configurar su cocina Meson's con una gama de materiales de excepcional calidad y durabilidad. Cada uno de ellos se ofrece en una paleta de tonos cuidadosamente seleccionada para vestir los volúmenes de su cocina con un carácter y una personalidad inconfundibles.

Materici / Textured-melamines / Materico / Dekor / Materico

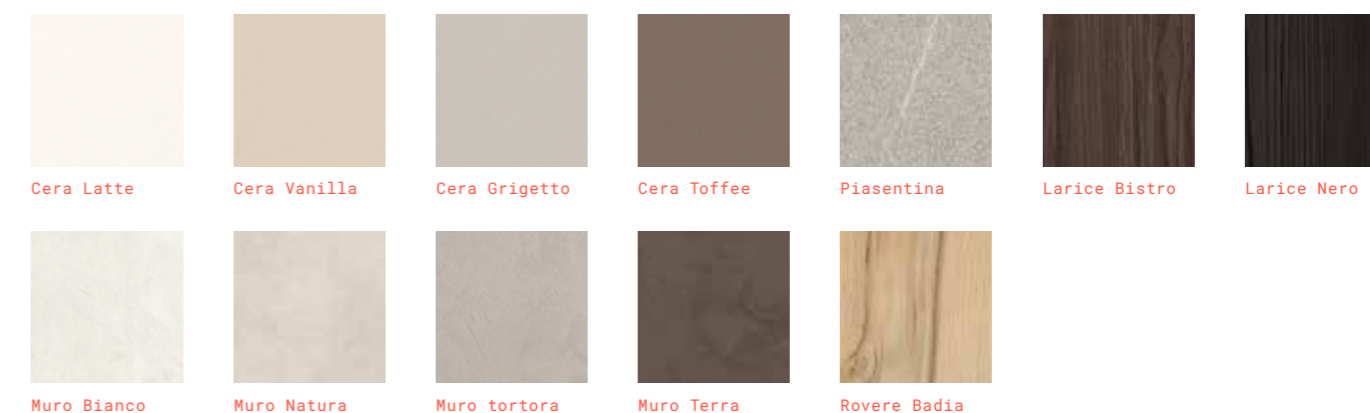

Materici Plus / Plus Textured-melamines / Materico Plus / Dekor Plus / Materico Plus



Materici Extra / Extra Textured-melamines / Materico Extra / Dekor Extra / Materico Extra





Laminati Omnia / Omnia Laminates / Stratifiés Omnia / Omnia Laminate / Laminados Omnia

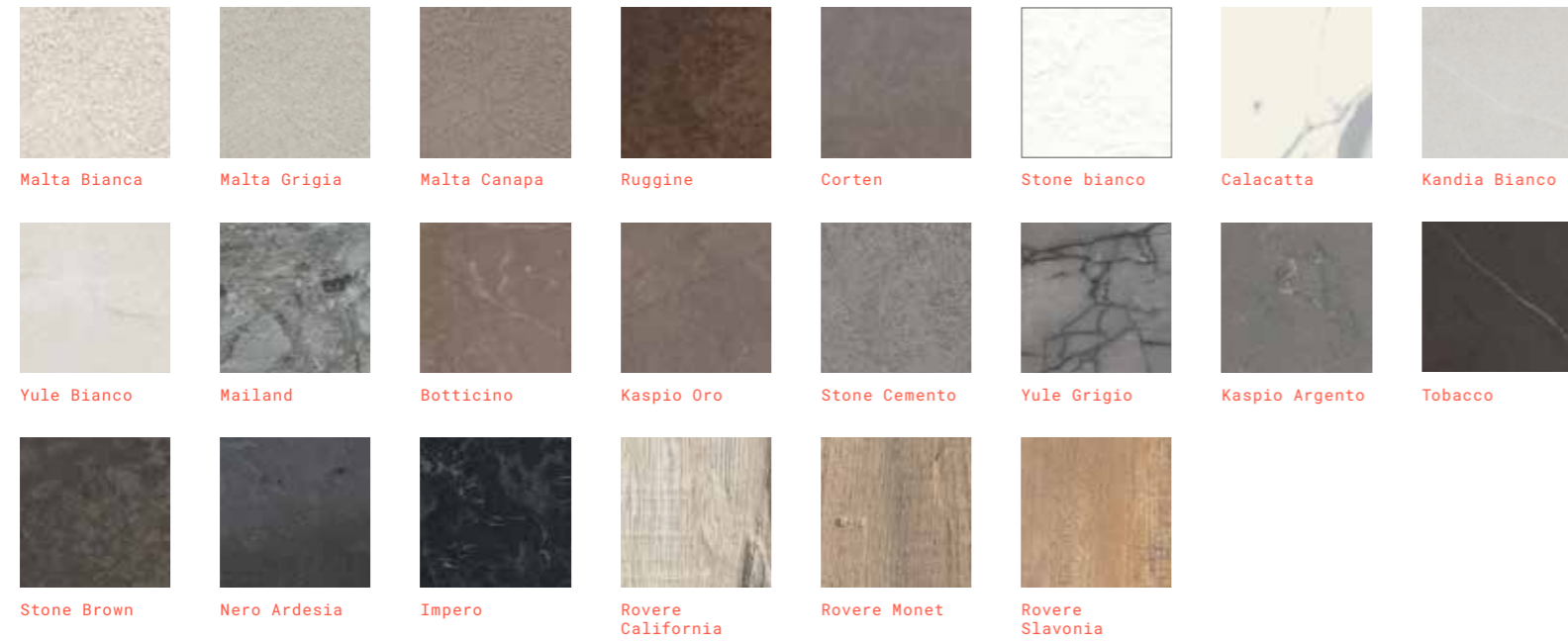

Laminati Unicolor / Unicolor Laminates / Stratifiés Unicolor / Unicolor Laminate / Laminados Unicolor

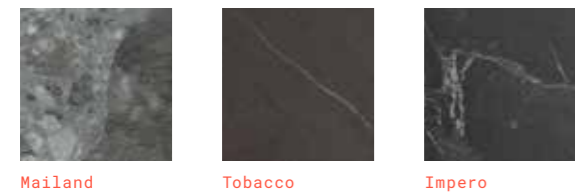

Fenix NTM\*



Fenix Unicolor



Laccati Opachi e Lucidi / Matt and Gloss Laquers / Laqués Mates et Brillantes / Matte und Hochglanz Lackierungen / Lacados Mate y Brillos



Laccati Calce / Calce Laquers / Laqués Calce / Calce Lackierungen / Lacados Calce

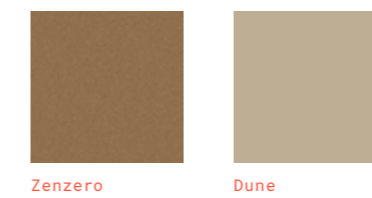

Laccati Metallici / Metallic Lacquers / Laqués métallisé / Metalloptik Lackierungen / Lacados metálicos



Ottone Bronzeo Rame

Laccati Ossidati / Oxidized Lacquer / Laqué Oxydé / Oxidiert Lackiert / Lacado Oxidado



Cacao Lava Nichel Nuvolato Platino Nuvolato Grafite Graffiato Ottone Graffiato Rame

Laccati Tecc / Tecc Lacquers / Laqués Tecc / Tecc Lackierungen / Lacados Tecc



Bianco 72 Grigio 99 Visone 07 Grafite 74 Nero 13

Acciaio / Stainless Steel / Acier / Stahl / Acero



AX Satinato AX Vintage BZ ice

Vetri Decor / Decor Glass / Verre Decor / Decor Glas / Cristal Decor



Bianco Carrara Amani Grigio Amani Daino Sahara Nero Marquinia Ebano

Vetri Acidati e Lucidi / Etched and Gloss Glass / Verre Dépoli et Brillant / Geätzttem und Hochglanz Glas / Cristal Mate y Brillo



Artico Magnolia Grigio Corda Efeso Fx Ardesia Ferro Grigio Fx Antracite



Nero Bianco 10 Canapa Steppa Juta Visone Creta Terranova



Gris Brown Salvia Timo Muschio Aftereight Ghiaccio Pervinca



Avio Senape Cuoio

Corian®



Glacier White

Terre



Bianco Perlescente Nero Roma Nero Vite Germania Terra Bruciata

Laminam



Pietra di Savoia Grigia Bocciardata    Ossido Nero    Ossido Bruno    Bianco Altissimo Venato Soft Touch    Noir Desir Opaco    Nero Greco Opaco

Laminam In-Side



Cardoso Grigio Fiammato    Cardoso Nero Fiammato    Piasentina Grigia Fiammata

Lapitec

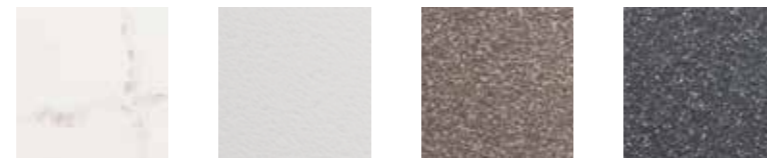

Musa Elettra Satin    Bianco Assoluto Lithos    Terra Ebano Lithos    Nero Antracite Lithos

Marmi / Marbles / Marbre / Marmor / Mármoles



Bianco Carrara    Calacatta Vagli Oro    Collemandina    Pietra Grey    Portoro Imperiale

Agglomerati Base / Base Composite Stones / Agglomeré Base / Base Agglomerat / Agglomerados Base



Aosta    Salento    Monviso    Dolomite    Vesuvio

Agglomerati Deluxe / Deluxe Composite Stones / Agglomeré Deluxe / Deluxe Agglomerat / Agglomerados Deluxe

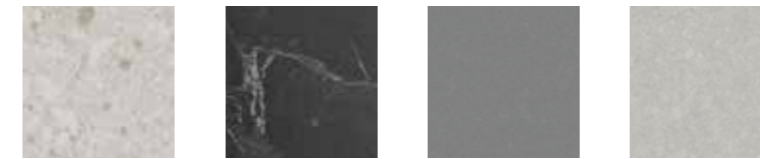

Impero Meringa    Impero Nero    Concrete Grigio    Serena

Essenze Premium / Premium Veneer / Plaqué Premium / Premium-Furnierholz / Contrachapado Premium



Cenere    Ossidiana    Ambra    Natura

Essenze Premium Fresata / Premium Milled Veneer / Plaqué Premium Fraisée / Premium Gemahlene Furnierholz / Contrachapado Premium con ranura

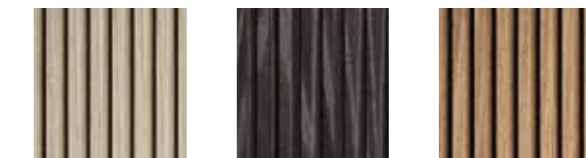

Cenere    Ossidiana    Ambra

Essenze Olmo / Olmo veneer / Plaqué Olmo / Olmo HolzAusführungen / Contrachapado Olmo



Olmo Naturale    Olmo Gesso    Olmo Tabacco    Olmo Cenere    Olmo Fumo    Olmo Grigio    Olmo Lava

Impiallacciati Rovere Colore / Stained Oak Veneer / Plaqué Chêne Couleur / Farbig lackierte Eichenfurnier / Contrachapados Roble Colorado



Rovere Gesso    Rovere Argilla    Rovere Cenere    Rovere Grigio    Rovere Brown    Rovere Carbone

Essenze Rovere Nodato / Rovere Nodato Veneers / Plaquages Rovere Nodato / Rovere Nodato Holzausführungen / Contrachapados Rovere Nodato



Rovere Nodato Naturale



Rovere Nodato Caramel



Rovere Nodato Argilla



Rovere Nodato Scuro



Rovere Termotrattato

Essenza Rovere Termotrattato / Veneer Plaqués Rovere Termotrattato / Rovere Termotrattato Holzausführung / Contrachapado Rovere Termotrattato

Essenze in bilia / Wood grain matching / Plaquage dans la même veine de bois / Durchgängiges Furnierbild / Enchapados con vetas simétricas

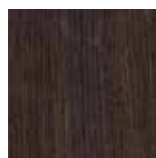

Rovere Termotrattato



Olmo Sbiancato



Noce Tecnico



Memory Wood



Quercia Tavolato

Legno Massello / Solid Wood / Bois Massif / Massivholz / Madera Maciza

<sup>IT</sup> Ogni cucina Meson's è costruita per assicurare un benessere di utilizzo totale e una produzione rispettosa dell'ambiente.

Ogni aspetto riguardante la produzione di una cucina Meson's segue un codice etico che rispecchia la filosofia propria delle persone che ne sono alla guida. Ne discendono una totale dedizione a garantire l'utilizzatore da ogni punto di vista e ad assicurare un utilizzo virtuoso delle risorse del pianeta. Da questo approccio generale è conseguita una naturale coerenza con i requisiti richiesti dai principali enti certificatori. Tra i marchi di garanzia ottenuti dall'azienda:

\_la certificazione FSC®, che garantisce la tracciabilità del legno e la provenienza da foreste fruite in modo responsabile, rilasciata dal Forest Stewardship Council®, organizzazione di cui fanno parte gruppi come Greenpeace e WWF, comunità indigene, ricercatori e altre entità coinvolte nel tema deforestazione;

\_la certificazione CARB2, che garantisce il rispetto dei limiti di emissione di formaldeide richiesti dal California Air Resources Board;

\_la certificazione di conformità agli standard di qualità ISO 9001:2015 per la progettazione, produzione e commercializzazione di mobili e complementi d'arredo.

<sup>EN</sup> Each Meson's kitchen is built to ensure a well-being of total use and an environmentally friendly production.

Every aspect concerning the production of a Meson's kitchen follows an ethical code that reflects the philosophy of the people who lead it. The result is a total dedication to guarantee the user from every point of view and to ensure a virtuous use of the planet's resources. From this general approach derives a natural coherence with the requisites requested by the main certifying bodies. Among the guarantee marks obtained by the company:

\_FSC® certification, that guarantees the traceability of the wood and the origin from forests used in a responsible way, issued by the Forest Stewardship Council®, an organization which includes groups such as Greenpeace and WWF, indigenous communities, researchers and other entities involved in the topic deforestation;

\_CARB2 certification, that guarantees compliance with the formaldehyde emission limits required by the California Air Resources Board;

\_certification of compliance with ISO 9001: 2015 quality standards for the design, production and marketing of furniture and furnishing accessories.

Meson's kitchen portraits

<sup>FR</sup> Chaque cuisine Meson's est fabriquée pour assurer un bien-être total à l'utilisateur et pour respecter pleinement l'environnement.

Chaque aspect concernant la fabrication d'une cuisine Meson's suit un code éthique qui reflète la philosophie des personnes qui dirigent l'entreprise. Le résultat qui en découle est un engagement total afin de garantir tant la sécurité de l'utilisateur à tout point de vue et qu'une utilisation vertueuse des ressources de la planète. Ce type d'approche générale a engendré une connexion naturelle avec les exigences requises par les principaux organismes certificateurs. Parmi les labels obtenus par l'entreprise, citons:

\_la certification FSC®, garantissant la traçabilité du bois et sa provenance de forêts exploitées de façon responsable, délivrée par le Forest Stewardship Council®, organisation dont font partie des groupes comme Greenpeace et le WWF, des communautés indigènes, des chercheurs et d'autres organismes concernés par le thème de la déforestation;

\_la certification CARB Phase 2 garantissant que les émissions de formaldéhyde sont inférieures aux limites établies par le California Air Resources Board;

\_la certification de conformité à la norme Qualité ISO 9001:2015 pour la conception, la fabrication et la commercialisation de meubles et de compléments d'ameublement.

<sup>DE</sup> Jede Küche Meson's ist so konzipiert, dass sie vollen Benutzerkomfort und eine umweltverträgliche Produktion garantiert.

Bei der Erzeugung einer Küche Meson's wird jeder einzelne Vorgang einem Ethikkodex unterworfen, der die Philosophie der Menschen, die dahinter stehen, widerspiegelt. Das Ergebnis ist ein umfassendes Engagement, um den Benutzer in jeder Hinsicht zufriedenzustellen und einen verantwortungsvollen Umgang mit den Ressourcen des Planeten sicherzustellen. Dieser allgemeine Ansatz hat zu einer logischen Kohärenz mit den Anforderungen der wichtigsten Zertifizierungsstellen geführt. Zu den Qualitätssiegeln des Unternehmens zählen:

\_die FSC®-Zertifizierung, die die Herkunft des verwendeten Holzes aus Wäldern mit nachhaltiger Bewirtschaftung und seine Rückverfolgbarkeit garantiert, ausgestellt vom Forest Stewardship Council®, einer Organisation, zu deren Mitgliedern Greenpeace und WWF, indigene Gemeinschaften, Forscher und andere Einrichtungen gehören, die sich mit dem Thema Abholzung befassen;

\_die CARB2-Zertifizierung, die die Einhaltung der vom California Air Resources Board geforderten Grenzwerte für Formaldehydemissionen gewährleistet;

\_die Konformitätsbescheinigung im Bezug auf die Qualitätsnorm ISO 9001:2015 für die Planung, die Produktion und den Vertrieb von Möbeln und Einrichtungsgegenständen.

<sup>ES</sup> Cada cocina Meson's está fabricada para garantizar un bienestar total en el uso y una producción respetuosa con el medio ambiente.

Todos los aspectos relacionados con la producción de una cocina Meson's siguen un código ético que refleja la filosofía de las personas que la dirigen. Esto se traduce en una dedicación total a fin de garantizar al usuario desde todos los puntos de vista y asegurar un uso virtuoso de los recursos del planeta. A partir de este enfoque general se logra una natural coherencia con los requisitos dispuestos por los principales organismos de certificación. Entre las marcas de garantía obtenidas por la empresa:

\_certificación FSC®, que garantiza la trazabilidad de la madera y el origen de las selvas explotadas responsablemente, emitida por el Forest Stewardship Council®, una organización a la que pertenecen grupos como Greenpeace y WWF, comunidades indígenas, investigadores y otras entidades involucradas en el tema de la deforestación;

\_certificación CARB2, que garantiza el cumplimiento de los límites de emisión de formaldehído exigidos por California Air Resources Board;

\_certificación del cumplimiento de las normas de calidad ISO 9001:2015 para el diseño, la producción y comercialización de muebles y complementos de decoración.

Legenda Icone / Icons Legend / Légende des icônes / Icon Legende / Icono Leyenda



Maniglie / Handles / Poignée / Griff / Tirador



Penisola / Peninsula / Péninsule / Halbinsel / Peninsula



Top base / Worktop / Plan de travail / Arbeitsplatte / Encimera



Muretto / Muretto upright / Élément Muretto / Muretto Element / Elemento Muretto



Tavolo / Table / Table / Tisch / Mesa



Boiserie / Wall panelling / Boiserie / Täfelung / Boiserie



Isola / Island / Îlot / Insel / Isla



Base / Base unit / Meubles bas / Unterschränke / Muebles bajos



Colonne / Tall units / Colonnes / Hochschränke / Columns



Top isola / Island worktop / Îlot plan de travail / Arbeitsplatte / Encimera isla



Pensile / wall unit / Éléments hauts / Hängeschränke / Muebles altos



Elementi a giorno / Open compartment / Compartiments ouverts / Offene Elemente / Elementos abiertos

**Cucine lineari o ad isola,  
angolari o a penisola:  
ogni cucina è un progetto unico.  
Un progetto che parte  
dall'interpretazione dello spazio  
per definire un ambiente cucina  
caratterizzato da armonia estetica  
e soluzioni tecnologiche  
in grado di rispondere  
ad ogni esigenza funzionale.**

**EN** Kitchens with islands or peninsula units, corner or linear layouts: each kitchen is a unique project. A project that starts from the interpretation of space to define a kitchen environment characterised by aesthetic harmony and technological solutions able to respond to every functional need.

**FR** Cuisine linéaire ou avec îlot, cuisine d'angle ou péninsule: chaque cuisine est un projet unique. Un projet qui part de l'interprétation de l'espace pour définir une ambiance de cuisine caractérisé par une harmonie esthétique et des solutions technologiques capables de répondre à chaque besoin fonctionnel.

**DE** Lineare Küchen oder mit Insel, Ecke oder Halbinsel: jede Küche ist ein einzigartiges Projekt. Ein Projekt, das von der Interpretation des Raumes ausgeht, um ein Küchenambiente zu definieren, das sich durch ästhetische Harmonie und technologische Lösungen auszeichnet, die alle funktionalen Anforderungen erfüllen.

**ES** Cocinas lineales o con isla, en esquina o en península: cada cocina es un proyecto único. Un proyecto que parte de la interpretación del espacio para definir un entorno en la cocina caracterizado por la armonía estética y las soluciones tecnológicas capaces de responder a cualquier necesidad funcional.

## Composizioni lineari / Linear layout / Linéaire / Zeile / Lineal

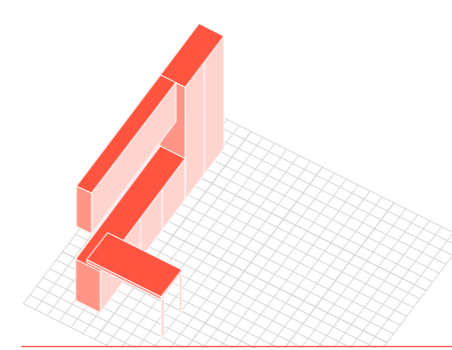
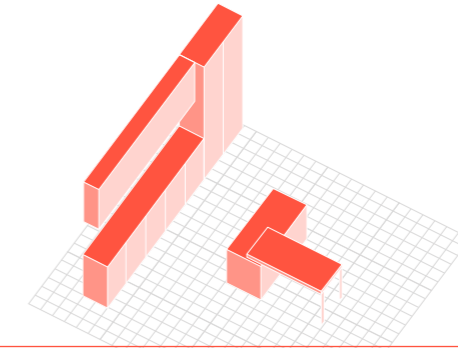
M2 Linea  
p. 78M2 Monoliti  
p. 110

## Composizioni ad angolo / Corner layout / d'angle / Eck / Angular

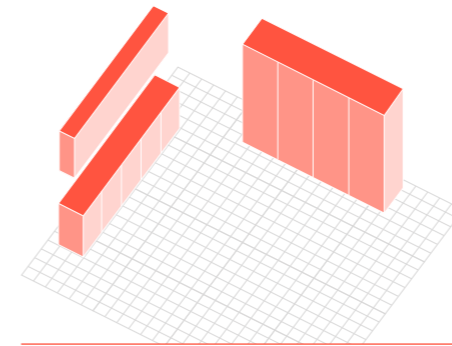
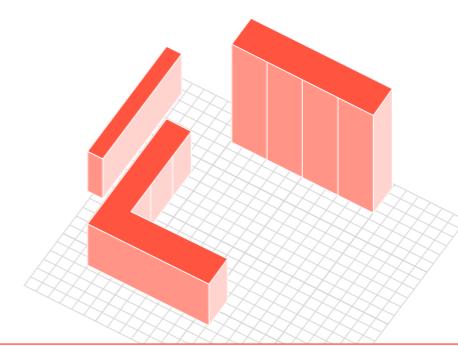
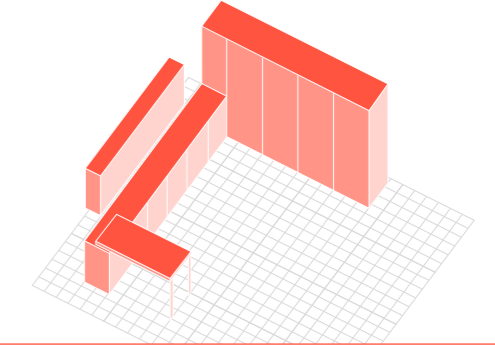
ME Slim  
p. 24  
ME Materia  
p. 52  
M2 Goccia  
p. 70  
M2 Goccia  
p. 74ME Trim  
p. 32  
ME Trim  
p. 38  
M2 Linea  
p. 96  
M2 Memo  
p. 116M6 Vela  
p. 124

## Composizioni ad isola / Island layout / îlot / Insel / Isla

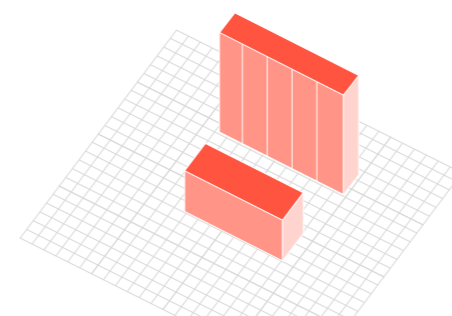
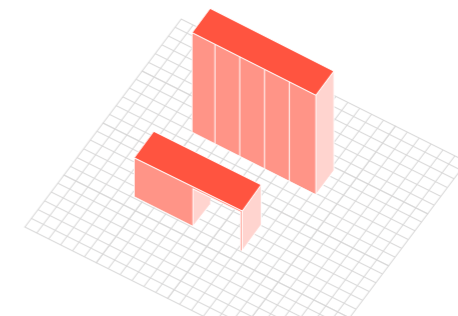
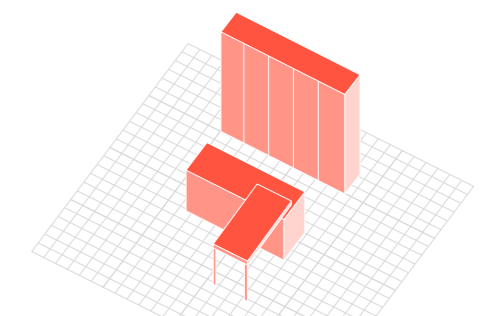
ME Slim  
p. 16  
M2 Linea  
p. 84  
M2 Crea  
p. 104ME Slim  
p. 8  
ME Murano  
p. 44  
M6 Presa  
p. 130ME Materia  
p. 56  
M2 Goccia  
p. 64  
M2 Linea  
p. 90  
M6 Profili  
p. 134



D00BC72

---

**Meson's**

**Servizio clienti**

**International department**

**Credits**

---

Meson's Cucine srl  
Via Gradisca, 1  
33087 Pasiano di  
Pordenone  
Pordenone, Italy  
T +39 0434 614911  
F +39 0434 628042  
www.mesons.it

T +39 0434 614906  
F +39 0434 628042  
mesons@mesons.it

T +39 0434 614972  
F +39 0434 628042  
mesons@mesons.it

Direzione artistica:  
M'Studio

†† Le illustrazioni sono  
tratte da "Herbarium Taste" di  
Valentina Raffaelli edito da  
Corraini Edizioni

EM The graphics are taken from  
"Herbarium Taste" by Valentina  
Raffaelli published by Corraini  
Edizioni

Edizione 2023



Questo catalogo è oggetto di copyright.  
Tutti i diritti di immagini e contenuti sono riservati e appartengono agli autori e a Meson's Cucine srl. L'eventuale riproduzione, anche parziale, dei contenuti dovrà essere richiesta e autorizzata per iscritto da Meson's Cucine srl.

L'azienda si riserva di introdurre senza preavviso eventuali modifiche tecnico-costruttive sul prodotto e sulle composizioni presentate.

This catalogue is protected by a copyright.  
All the rights and images contained herein are reserved and belong to the authors and to Meson's Cucine srl. Reproduction, even partial, of the contents must be requested and authorised in writing by Meson's Cucine srl.

Meson's reserves the right to include any technical/constructional changes to the product and the presented arrangements without prior notice.



**MESON'S**