

M2

MESON'S

M2 Collection

M2 è un sistema per l'arredamento della cucina che offre un nuovo spettro di soluzioni all'esigenza di rendere questo spazio personale e ricco di tutti i moderni comfort. Meson's ha anche concepito il sistema M2 con l'obiettivo di rendere la cucina un luogo capace di esprimere bellezza e prestigio e di interagire con l'area living senza soluzione di continuità. Uno spazio che parli di noi, che sia una cornice accogliente nelle occasioni di convivialità e che assecondi con comfort e funzionalità i momenti dedicati alla preparazione del cibo. La collezione M2 è design, innovazione, tecnologia e tradizione in un perfetto mix. Nello spirito che identifica da più di cinquant'anni il marchio Meson's.

M2 is a kitchen furnishing system that offers new solutions to make this space personal and full of all modern comforts. Meson's has also designed the M2 system with the aim of making the kitchen a place able to express beauty and prestige and to interact with the living area without interruption. A space that talks about us, that is a welcoming frame for conviviality occasions and that supports the moments dedicated to food preparation with comfort and functionality. The M2 collection is design, innovation, technology and tradition in a perfect mix. In the spirit that identifies the Meson's brand for over fifty years.

M2 Goccia	8	Pergamena Rovere Cotto / Laccato Metallico Rame / Laminam Pietra di Savoia Grigia Bocciardata
	34	Materico Larice Bistrot / Fenix Verde Comodoro
	88	Laccato Opaco Grigio Corda / Materico Larice Bistrot / Laminato Impero
M2 Monoliti	22	Pergamena Noce Italia / Laminato Impero
	122	Materico Cera Grigetto / Laminato Tabacco
	136	Materico Muro Natura / Fenix Beige Arizona / Laminato Lamiera
M2 Linea	48	Materico Plus Bianco / Fenix Nero / Essenza Olmo Sbiancato
	62	Laccato Opaco Carta da Zucchero / Materico Larice Nero / Laminam Pietra di Savoia Grigia Bocciardata
	98	Fenix Grigio Efeso / Fenix Grigio Bromo / Quercia Tavolato
M2 Crea	76	Materico Plus Bianco / Materico Plus Grigio Etna / Laccato Opaco Cuoio / Essenza Olmo Naturale
M2 Tecna	110	Laccato Lucido Cuoio / Laccato Lucido Magnolia / Essenza Olmo Cenere

Una cucina Meson's è un mondo. Un insieme di bellezza e tecnologia che si esprime attraverso un sapiente equilibrio di contrasti. Una cucina da godere in tutte le sue espressioni: dalla precisione delle proporzioni al linguaggio dei materiali, dalla qualità delle finiture e dei dettagli alla leggerezza del piano.

A Meson's kitchen is a world. A set of beauty and technology that is expressed through a careful balance of contrasts. A kitchen to be enjoyed in all its expressions: from the precision of the proportions to the language of the materials, from the quality of the finishes and the details to the lightness of the worktop.











M2 Goccia

Meson's



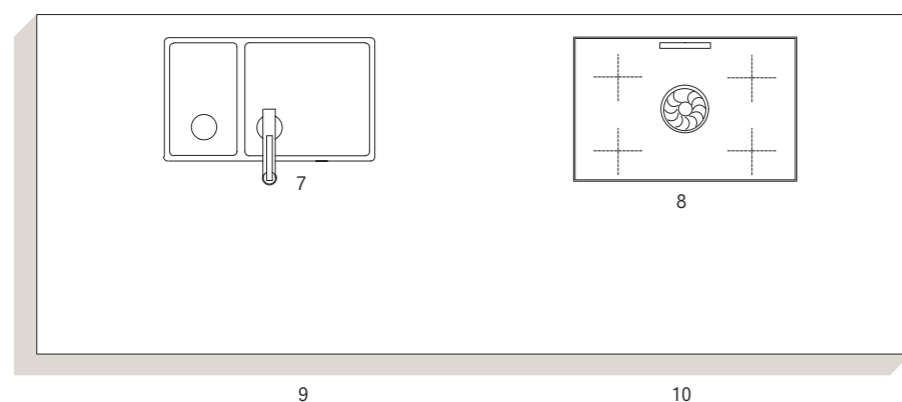
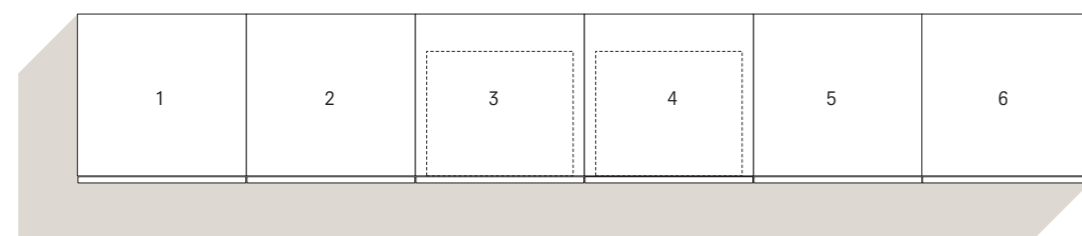

Colonne M2 Crea in finitura *Pergamena Rovere Cotto*¹ con la nuova maniglia Max in colore personalizzabile. Basi M2 Goccia in finitura *Laccato Metallico Rame*², cassetti di grandi dimensioni con doppia scocca per un maggiore comfort nell'apertura. Piano in *Laminam Pietra di Savoia Grigia Bocciardata*³.

Tall units M2 Crea in *Pergamena Rovere Cotto*¹ finish with the new Max handle in customizable colour. M2 Goccia base units in *Rame Metallico Lacquer*² finish, large drawers with double carcass for a greater comfort in the opening. Worktop in *Laminam Pietra di Savoia Grigia Bocciardata*³.

- 1 Colonna attrezzata con TAL GATE Planero.
Tall unit equipped with TAL GATE Planero.
- 2 Colonna frigo con anta battente.
Tall unit for fridge with hinged door.
- 3 Colonna forno AEG.
Tall unit for AEG oven.
- 4 Colonna microonde e scaldavivande AEG.
Tall unit for AEG microwave oven and plate warmer.

- 5 Colonna dispensa con anta ad apertura battente.
Pantry tall unit with hinged door.
- 6 Colonna dispensa con anta ad apertura battente.
Pantry tall unit with hinged door.
- 7 Lavello e miscelatore Foster.
Foster sink and mixer tap.
- 8 Piano cottura con cappa integrata AEG.
Hob with AEG integrated hood.

- 9 Base due cestoni composta con frontale unico L.150 cm.
Base unit composed of 2 deep drawers and a single front W.150 cm.
- 10 Base due cestoni composta con frontale unico L.150 cm.
Base unit composed of 2 deep drawers and a single front W.150 cm.

La tendenza a ridimensionarsi di molti spazi abitativi ci guida a progettare ambienti che vedono convivere, in perfetto equilibrio, l'insieme di funzionalità che una moderna cucina richiede con lo spirito e l'atmosfera di un sofisticato living room. M2 Monoliti di Meson's è l'interprete ideale di queste esigenze.

The trend to downsize many living spaces leads us to design environments that see, in perfect balance, the combination of features that a modern kitchen requires with the spirit and atmosphere of a sophisticated living room. M2 Monoliti of Meson's is the ideal interpreter of these needs.







M2 Monoliti

Meson's





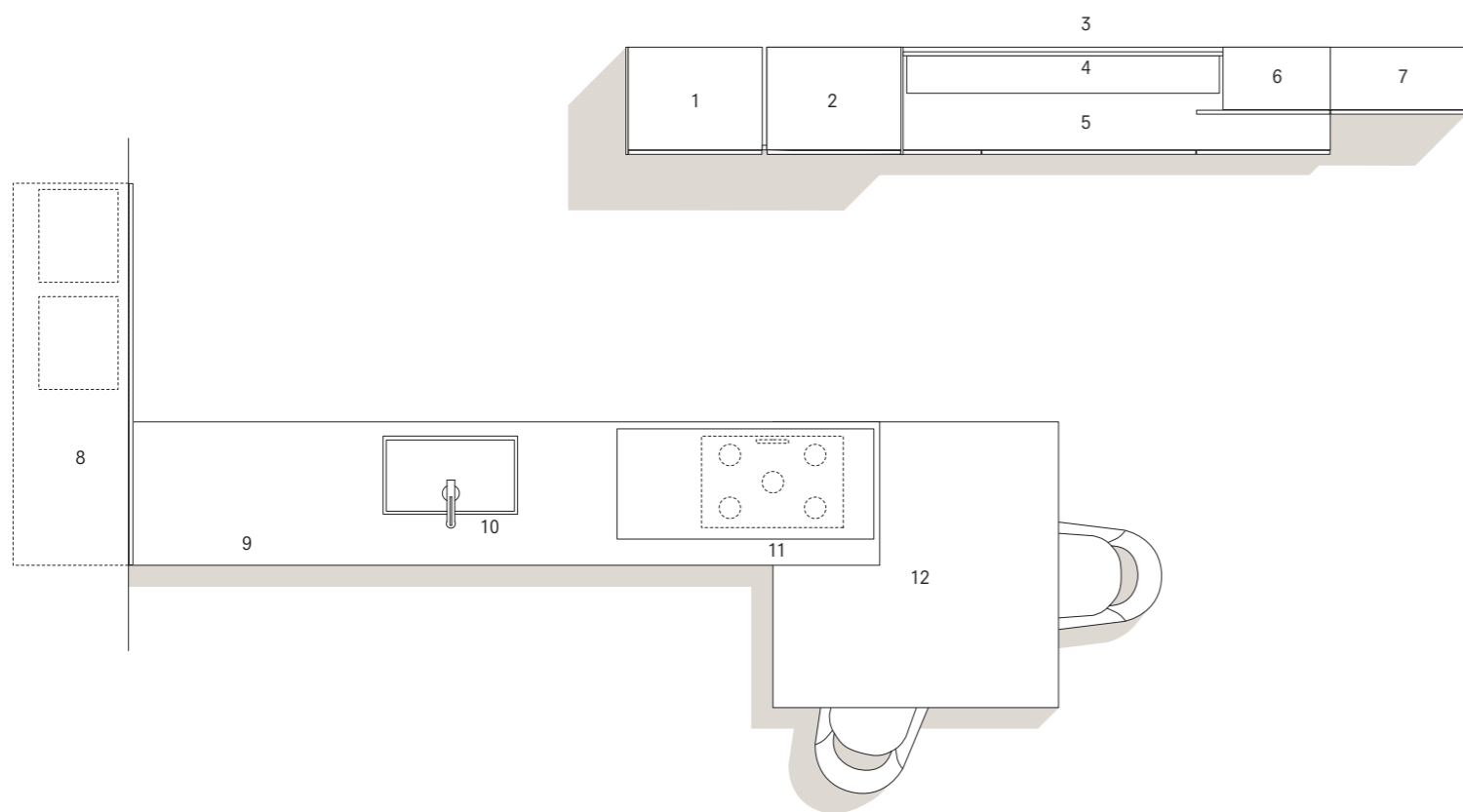

Penisola in *Laminato Impero*² con vasca integrata nel piano. Composizione da parete con colonne in *Pergamena Noce Italia*¹, base cestone sospesa e boiserie centrale in *Laminato Impero*. Pensile con grande anta planare in *Pergamena Noce Italia*.

Peninsular unit in *Impero Laminate*² with sink integrated into the worktop. Wall composition with tall units in *Pergamena Noce Italia*¹, hanging deep drawer base unit and central wall paneling in *Impero Laminate*. Wall unit with large lift up door in *Pergamena Noce Italia*.

- 1 Colonna frigo con anta ad apertura battente. Tall unit for fridge with hinged door.
- 2 Colonna dispensa sospesa con anta battente. Hanging pantry tall unit with hinged door.
- 3 Boiserie. Wall paneling.
- 4 Mensola per boiserie. Shelf for wall paneling.
- 5 Base cestone sospesa. Hanging deep drawer base unit.

- 6 Colonna dispensa con anta sporgente. Pantry tall unit with protruding door.
- 7 Colonna dispensa con anta battente. Pantry tall unit with hinged door.
- 8 Elemento sporgente pensile con anta planare attrezzata con forni compatti Siemens. Jutting wall unit with lift up door equipped with Siemens compact ovens.

- 9 Base cassetto sospesa. Hanging drawer base unit.
- 10 Vasca integrata in laminato. Laminate integrated sink basin.
- 11 Piano cottura a induzione Siemens. Siemens induction hob.
- 12 Tavolo penisola 160 x160 cm. 160 x160cm Table/ Peninsular unit.

M2 Meson's rende possibile immaginare nuovi approcci alla progettazione degli spazi dove cucinare e vivere. Con colonne e boiserie che collegano la zona living alla cucina, con la possibilità di dedicare al forno uno spazio meno evidente, con nuove modalità di apertura dei pensili, con sopracolonne ad anta sporgente. Bentornati a casa.

Meson's M2 allows you to imagine new approaches to the design of spaces for cooking and living. With tall units and wall paneling that connect the living area to the kitchen, with the possibility to dedicate a less evident space to the oven, with new ways of opening the wall units, with tall unit top elements with protruding door. Welcome home.

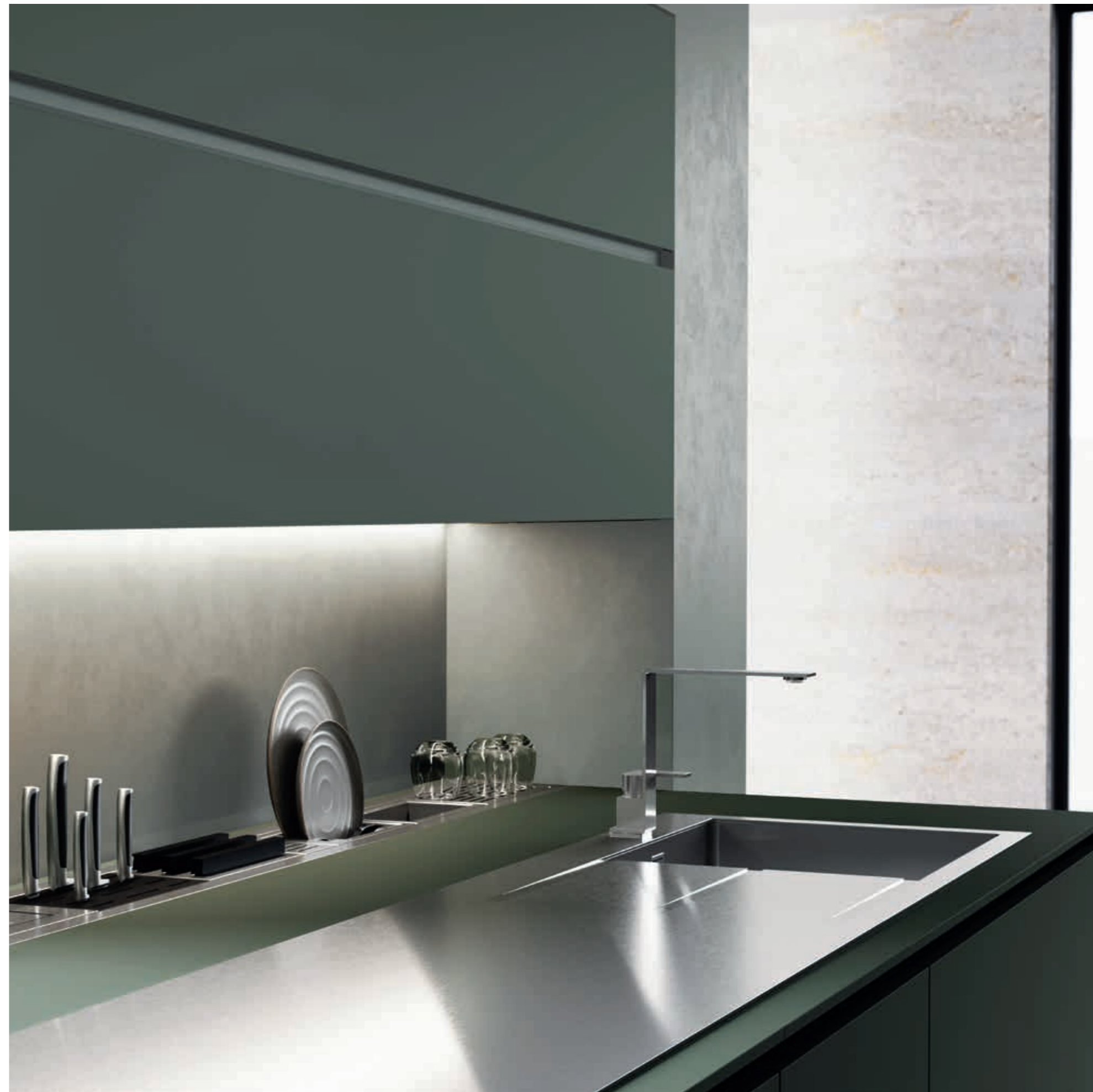

M2 Goccia

Meson's





M2 Goccia

Meson's





M2 Goccia

Meson's



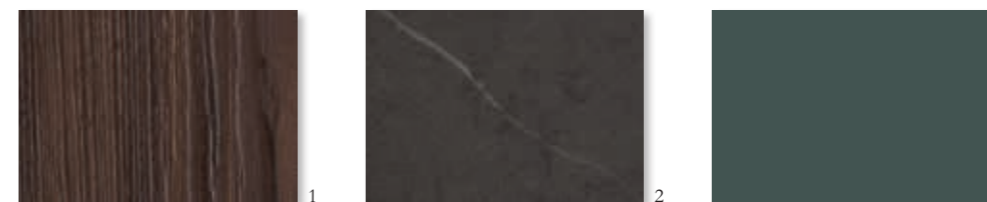
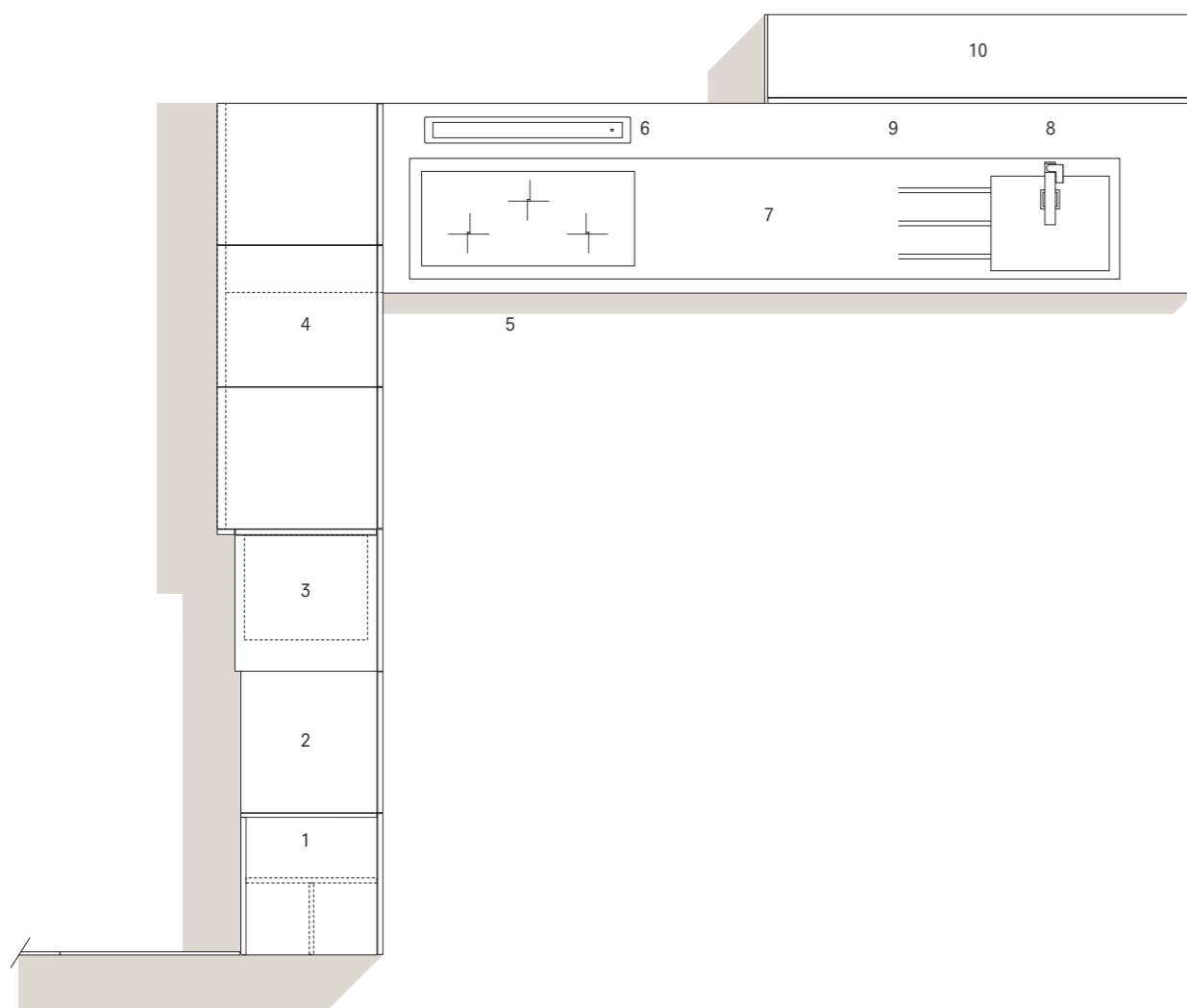

Composizione M2 Goccia con colonne in *Materico Larice Bistrot*¹ e boiserie in *Laminato Tobacco*². Basi e pensili in *Fenix Verde Comodoro*³. Top in *Fenix Verde Comodoro* e piano in acciaio Mood Fusion Barazza con vasca integrata.

M2 Goccia composition with tall units in *Larice Bistrot Textured-melamine*¹ and wall paneling in *Tobacco Laminato*². Base units and wall unit with in *Fenix Verde Comodoro*³. Worktop in *Fenix Verde Comodoro* and Barazza Mood Fusion steel worktop with integrated sink.

- | | | |
|--|--|---|
| 1 Colonna terminale a giorno. Open end tall unit. | 5 Base due cestoni con cassetto interno attrezzata di portaposate e accessori Fit. Base unit with two deep drawers and internal drawer equipped with Fit cutlery tray and accessories. | 8 Miscelatore Mood One Barazza. Barazza Mood One mixer tap. |
| 2 Colonna frigo con anta battente. Tall unit for fridge with hinged door. | 6 Cappa aspirante B_Draft Barazza. Barazza B_Draft extractor hood. | 9 Canale incassato accessorizzato Barazza. Barazza accessorised built-in channel. |
| 3 Colonna forno con apertura laterale. Tall unit for oven with side opening. | 7 Piano acciaio da incasso Mood Fusion Barazza attrezzato con piano cottura a induzione e lavello. Barazza Mood Fusion built-in steel worktop equipped with induction hob and sink. | 10 Pensile composto con apertura planare servo-drive. Composed wall unit with servo-drive lift up door. |
| 4 Sopracolonne con anta ad apertura battente. Tall unit top elements with hinged door. | | |

Materico Plus Bianco /
Fenix Nero /
Essenza Olmo Sbiancato

M2 Meson's interpreta il tema versatilità in modo totale, sia quando l'idea è di una cucina vestita su misura sia quando, come in questo caso, la scelta è di un moderno open space. Gli elementi che costituiscono l'ambiente dialogano così con l'insieme per creare un mondo neutro e, al tempo stesso, fortemente caratterizzato dallo stile delle persone.

Meson's M2 interpreta il tema di versatilità in un modo totale, sia quando l'idea è di una cucina su misura sia quando, come in questo caso, la scelta è di un moderno open space. Gli elementi che costituiscono l'ambiente dialogano così con l'insieme per creare un mondo neutro e, al tempo stesso, fortemente caratterizzato dallo stile delle persone.





M2 Linea

Meson's



M2 Linea

Meson's



M2 Linea

Meson's





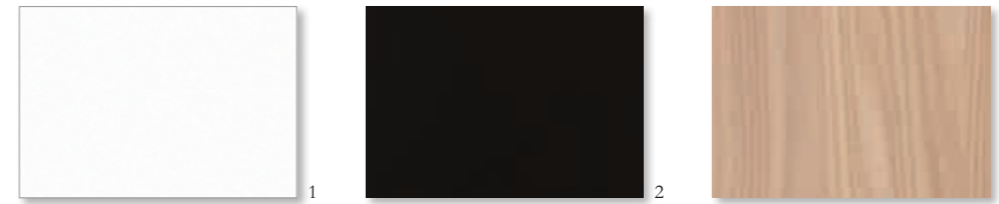
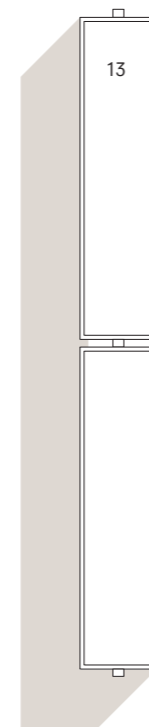
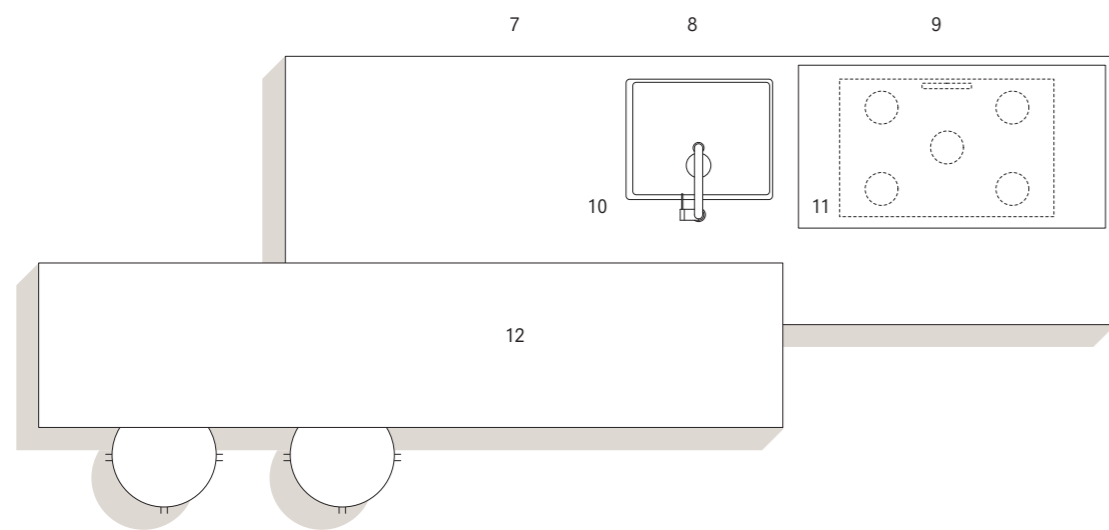
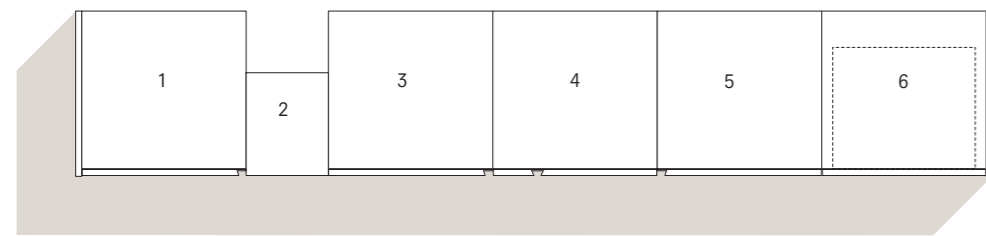

Isola con finitura coordinata tra ante, fianchi e top in *Fenix Nero*². Colonne free standing in *Materico Plus Bianco*¹ con elemento a giorno in *Essenza Olmo Sbiancato*³. Stessa finitura anche per il grande bancone snack di spessore 60 mm.

Island with coordinated finish between doors, side panels and worktop in *Fenix Nero*². Free standing tall units in *Plus Bianco Textured-melamine*¹ with open element in *Olmo Sbiancato Veneer*³. Same finish also for the large 60 mm thick breakfast bar.

- | | | |
|--|---|---|
| <p>1 Colonna dispensa con anta ad apertura battente. Pantry tall unit with hinged door.</p> <p>2 Colonna a giorno in essenza. Veneer open tall unit.</p> <p>3 Colonna frigo con anta battente. Tall unit for fridge with hinged door</p> <p>4 Colonna dispensa sospesa con anta apertura battente con profilo Linea doppio. Hanging pantry tall unit with hinged door with Linea double profile.</p> | <p>5 Colonna dispensa sospesa con anta ad apertura battente. Hanging pantry tall unit with hinged door.</p> <p>6 Colonna forno sospesa con forno Neff. Hanging tall unit for oven with Neff oven.</p> <p>7 Anta lavastoviglie. Dishwasher door.</p> <p>8 Base lavello accessoriata con pattumiera Tecnobig. Sink base unit equipped with Tecnobig dustbin.</p> <p>9 Base due cestoni e cassetto interno attrezzata con portaposate e accessori Fit.</p> | <p>Base unit with two deep drawers and internal drawer equipped with Fit cutlery tray and accessories.</p> <p>10 Lavello e miscelatore Foster finitura Gun Metal. Foster sink and mixer tap in Gun Metal finish.</p> <p>11 Piano cottura a induzione Neff. Neff induction hob.</p> <p>12 Snack in essenza sp. 6 cm. 6cm thick veneer breakfast bar.</p> <p>13 Sistema Palma con illuminazione a LED integrata. Palma system with integrated LED lighting.</p> |
|--|---|---|

Una cucina senza complessi, che sa essere protagonista con l'orgoglio del suo fondamentale ruolo e con la consapevolezza di un'estetica intrigante nei dettagli e nell'insieme. Una composizione spettacolare negli accostamenti e nei toni, coinvolgente nelle texture ed entusiasmante nella flessibilità e ricchezza delle dotazioni.

A kitchen without complexes, that knows how to be the protagonist with the pride of its fundamental role and with the awareness of an intriguing aesthetic in the details and in the whole. A spectacular composition in combinations and tones, engaging in textures and exciting in its flexibility and wealth of equipment.









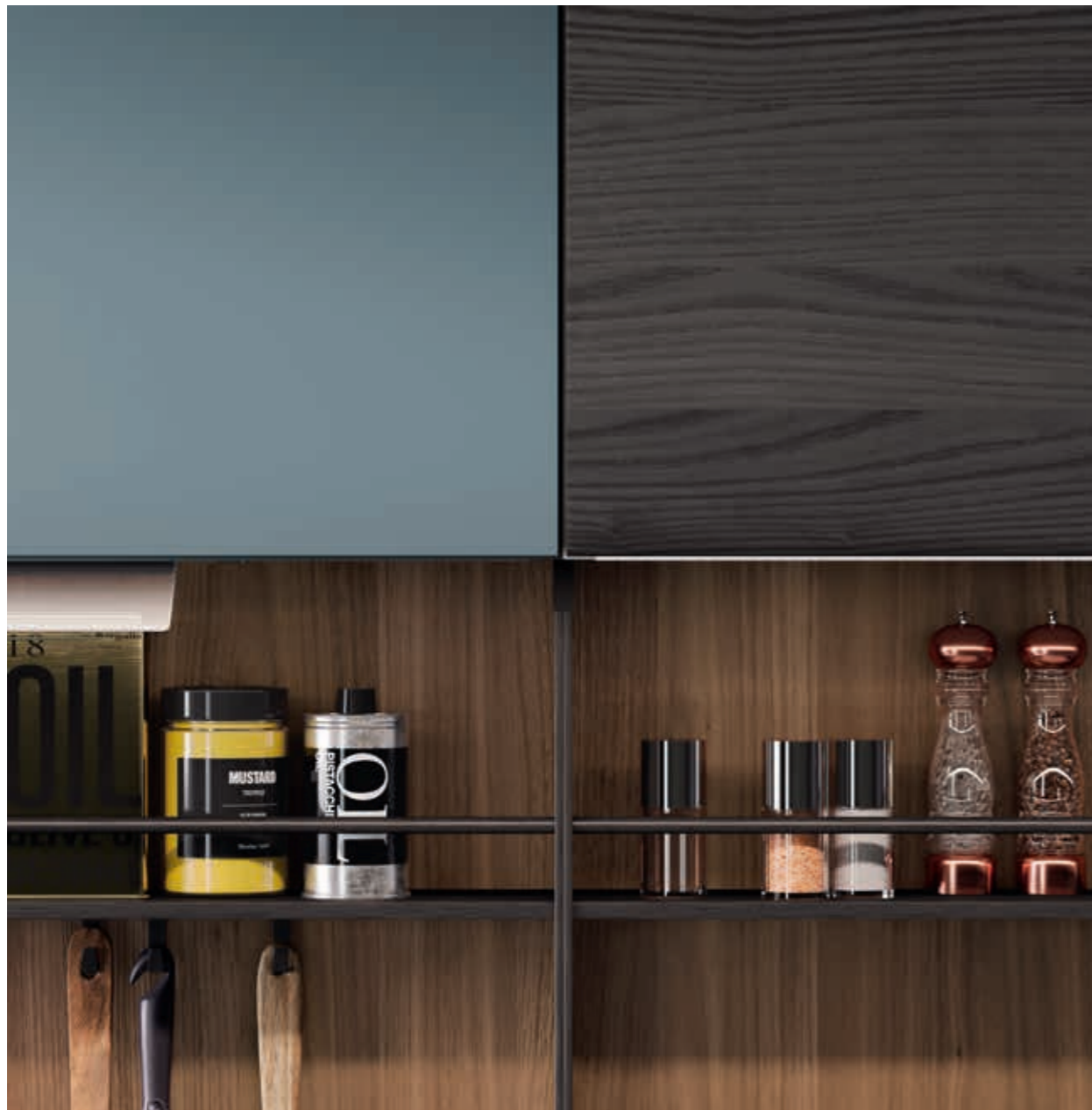



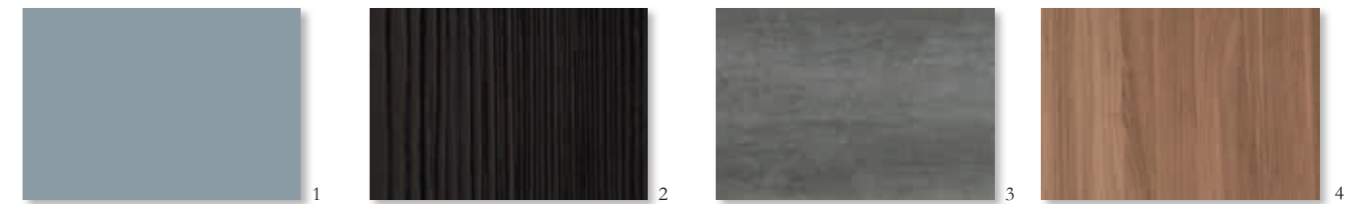
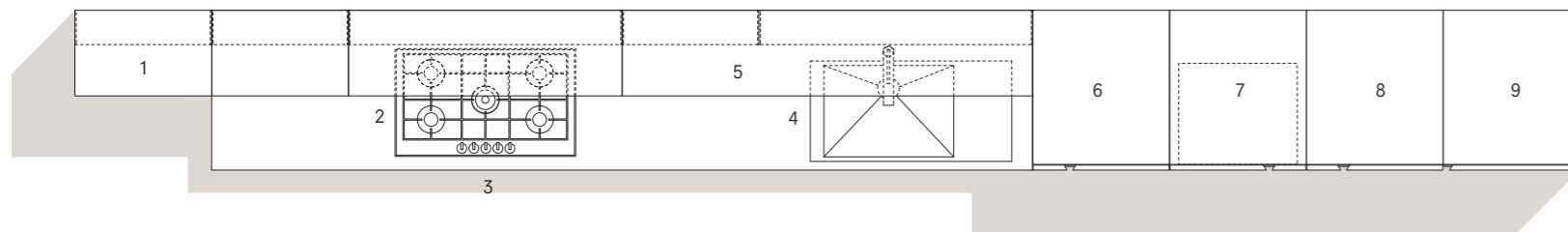

Cucina M2 Linea con basi e pensili in *Laccato Lucido Carta da Zucchero*¹ e gole in finitura opaca dello stesso colore. Colonne e pensile centrale in finitura *Materico Larice Nero*². Schienali in *Pergamena Noce Italia*⁴. Piano in *Laminam Pietra di Savoia Grigia Bocciardata*³.

M2 Linea kitchen with base and wall units in *Carta da Zucchero Gloss Lacquer*¹ and grip recesses in matt finish of the same colour. Tall units and central wall unit in *Larice Nero Textured-melamine*² finish. Back panels in *Pergamena Noce Italia*⁴. Worktop in *Laminam Pietra di Savoia Grigia Bocciardata*³.

1 Pensili con apertura anta battente con illuminazione a LED.
Wall units with hinged door and LED lighting.

2 Piano cottura Bosch.
Bosch hob.

3 Base cestoni e due cassetti attrezzata con portaposate e accessori Fit.
Base unit with deep drawers and two drawers equipped with Fit cutlery tray and accessories.

4 Lavello e miscelatore Franke.
Franke sink and mixer tap.

5 Accessori sotto pensile Modular.
Modular accessories under wall unit.

6 Colonna dispensa con anta ad apertura battente e cestoni.
Pantry tall unit with hinged door and deep drawers.

7 Colonna forno Bosch.
Tall unit for Bosch oven.

8 Colonna dispensa con anta ad apertura battente con profilo linea doppio.
Pantry tall unit with hinged door and Linea double profile.

9 Colonna frigo con anta battente.
Tall unit for fridge with hinged door.

Materico Plus Bianco /
 Materico Plus Grigio Etna /
 Laccato Opaco Cuoio /
 Essenza Olmo Naturale

M2 Crea in un progetto che vede il tavolo in olmo naturale fondersi con l'isola e dialogare con la grande mensola della composizione a parete. A lato di basi e pensili, le mensole integrate nella boiserie sdrammatizzano il rigore dell'insieme introducendo un elemento capace di fare da fondale alla bellezza degli oggetti che potrà ospitare.

M2 Crea in a project that sees the table in natural elm merge with the island and dialogue with the large shelf of the wall composition. Beside base and wall units, the integrated shelves in the wall paneling play down the rigor of the whole by introducing an element able to act as a background to the beauty of the objects it can accommodate.



M2-Crea

Mesa



M2 Crea

Meson's







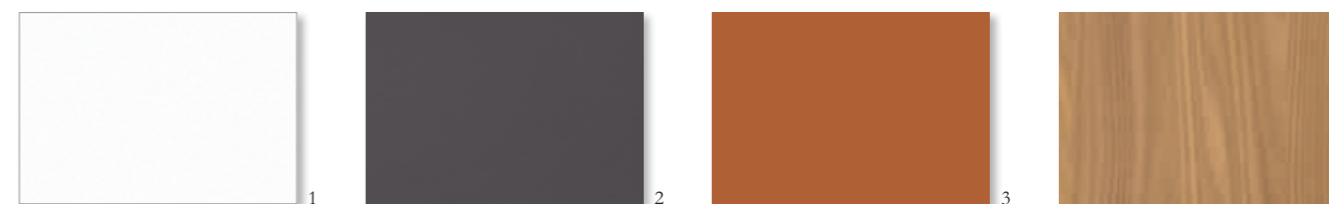
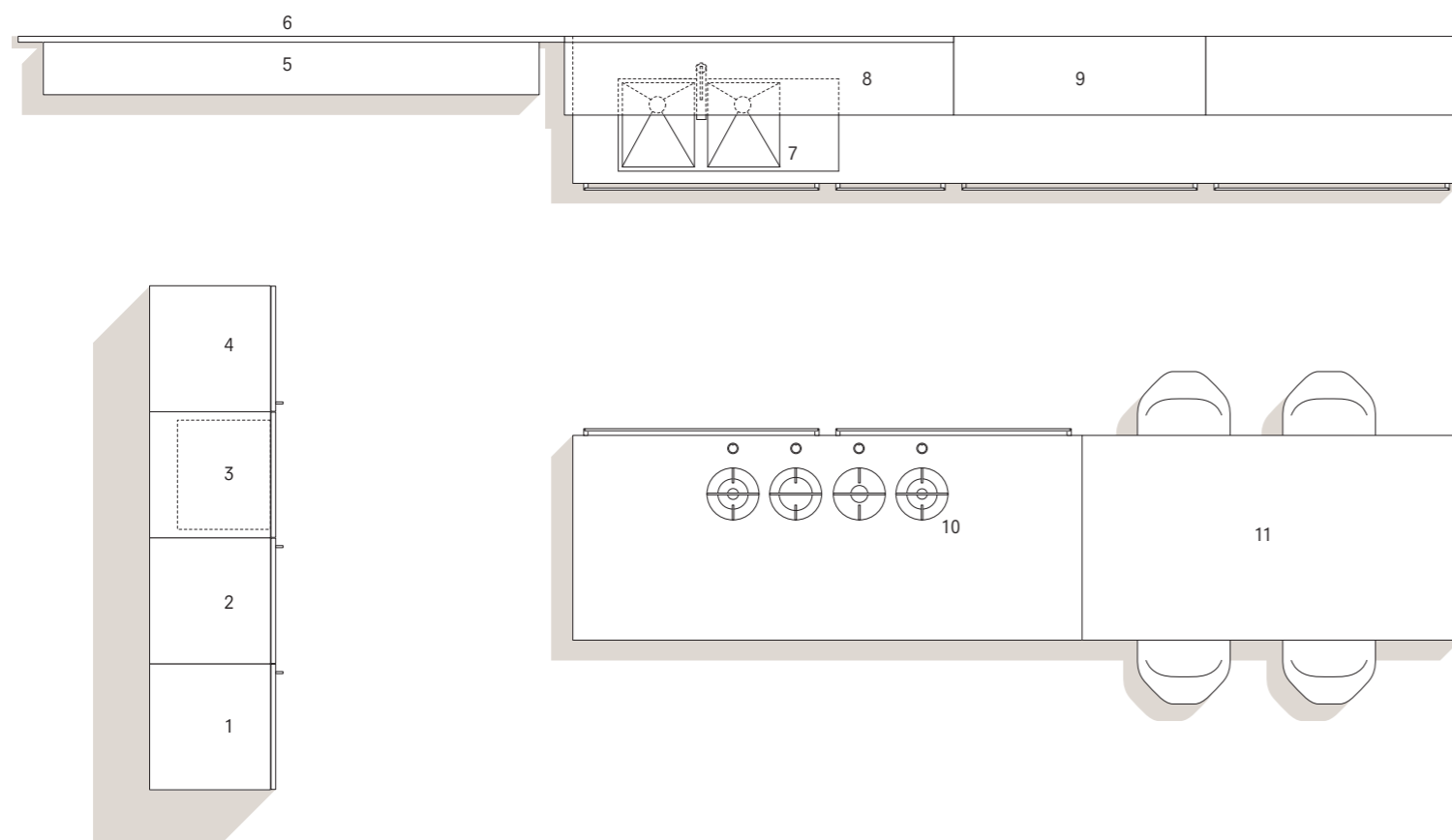

Basi e colonne in finitura *Materico Plus Bianco*¹ con maniglia Grip Inox. Pensili in *Materico Plus Grigio Etna*². Boiserie con mensole in finitura *Laccato Opaco Cuoio*³. Tavolo integrato nell'isola e mensola a parete in *Essenza Olmo Naturale*⁴.

Base and tall units in *Plus Bianco Textured-melamine*¹ finish with Stainless steel Grip handle. Wall units in *Plus Grigio Etna Textured-melamine*². Wall paneling with shelves in *Cuoio Matt Lacquer*³ finish. Table integrated into the island and wall shelf in *Olmo Naturale Veneer*⁴.

1 Colonna dispensa con anta ad apertura battente.
Pantry tall unit with hinged door.

2 Colonna frigo con anta battente.
Tall unit for fridge with hinged door.

3 Colonna forno e micro Barazza.
Tall unit with Barazza oven and microwave.

4 Colonna dispensa con anta ad apertura battente.
Pantry tall unit with hinged door.

5 Mensola Boiserie.
Wall panelling shelf.

6 Boiserie.
Wall panelling.

7 Lavello e miscelatore Barazza.
Barazza sink and mixer tap.

8 Mensola sp.4 cm.
4cm thick Shelf.

9 Pensile con anta ad apertura battente.
Wall unit with hinged door.

10 Piano cottura Barazza.
Barazza hob.

11 Tavolo penisola sp.4 cm.
4cm thick Table-Peninsular unit.

Una soluzione che declina le esigenze dell'abitare contemporaneo arredando lo spazio senza soluzione di continuità tra cucina e living. Il progetto si concretizza in un ambiente ricco di atmosfera che supera i limiti dimensionali della casa grazie all'eliminazione di separazioni fisiche tra le aree. La boiserie aggiunge all'insieme un esclusivo tono *tailor made*.

A solution that declines the needs of contemporary living by furnishing the space without interruption between kitchen and living area. The project takes shape in an environment rich in atmosphere that overcomes the dimensional limits of the house thanks to the elimination of physical separations between the areas. The wall paneling adds to the whole an exclusive tailor-made tone.









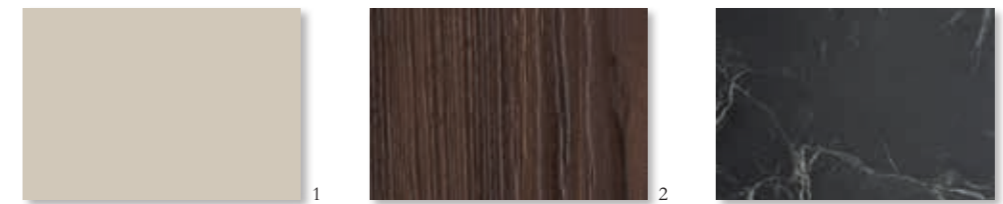
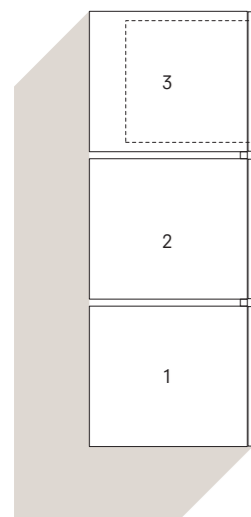
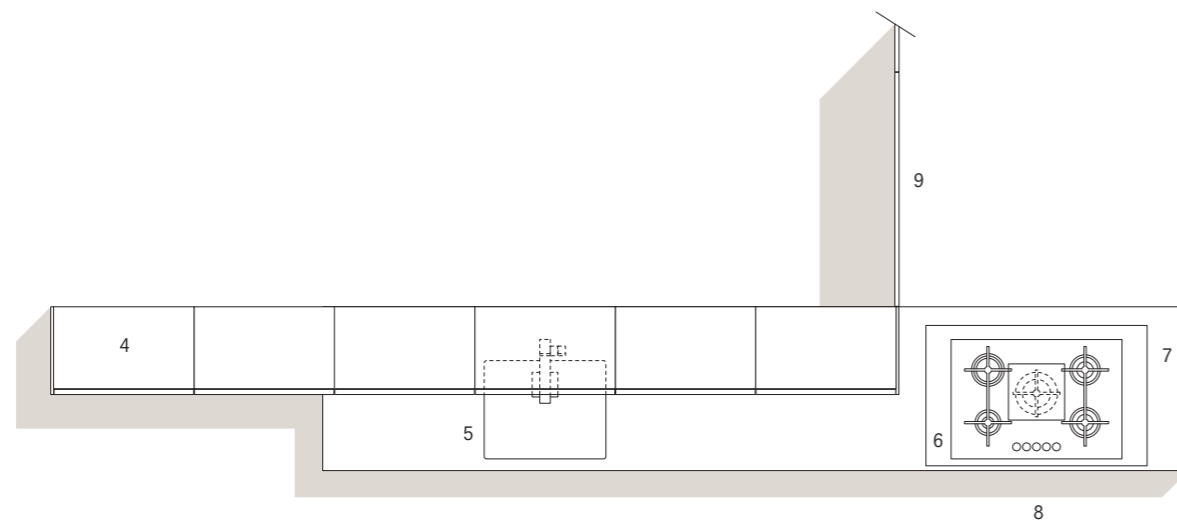

Cucina M2 Goccia con basi e colonne in finitura *Laccato Opaco Grigio Corda*¹, colonne sospese e pannellatura a parete in *Materico Larice Bistrot*². Piano top e schienale in *Laminato Impero*³.

M2 Goccia kitchen with base and tall units in *Grigio Corda Matt Lacquer*¹ finish, hanging tall units and wall panelling in *Larice Bistrot Textured melamine*². Worktop and back panel in *Impero Laminate*³.

- 1 Colonna dispensa con anta ad apertura battente. Pantry tall unit with hinged door.
- 2 Colonna frigo con anta battente. Tall unit for fridge with hinged door.
- 3 Colonna forni Whirlpool. Tall unit with Whirlpool ovens.
- 4 Colonna sospesa con anta battente e illuminazione Led. Hanging tall unit with hinged door and LED lighting.
- 5 Lavello sottotop e miscelatore Franke. Undermount sink and Franke mixer tap.

- 6 Piano cottura a gas Whirlpool. Whirlpool gas hob.
- 7 Cappa aspirante isola Libeccio. Libeccio island extractor hood.
- 8 Base due cestoni e cassetto interno attrezzata con portaposate e accessori Fit. Base unit with two deep drawers and internal drawer equipped with Fit cutlery tray and accessories.
- 9 Pannelli boiserie. Wall panels.

Il segno inconfondibile di M2 Linea in uno spazio equilibrato e personale. Una composizione nella quale convivono, in perfetta armonia estetica, il calore e la matericità del bancone in tavolato di quercia e la grafica delle linee che attraversano l'isola e le colonne. Scelte che parlano un linguaggio raffinato in una casa capace di rimanere a lungo attuale.

The unmistakable sign of M2 Linea in a balanced and personal space. A composition in which, in perfect aesthetic harmony, the warmth and materiality of the oak breakfast bar and the graphics of the lines that cross the island and the tall units coexist. Choices that speak a refined language in a home that can remain current for a long time.



M2 Linea

Meson's







M2 Linea

Meson's



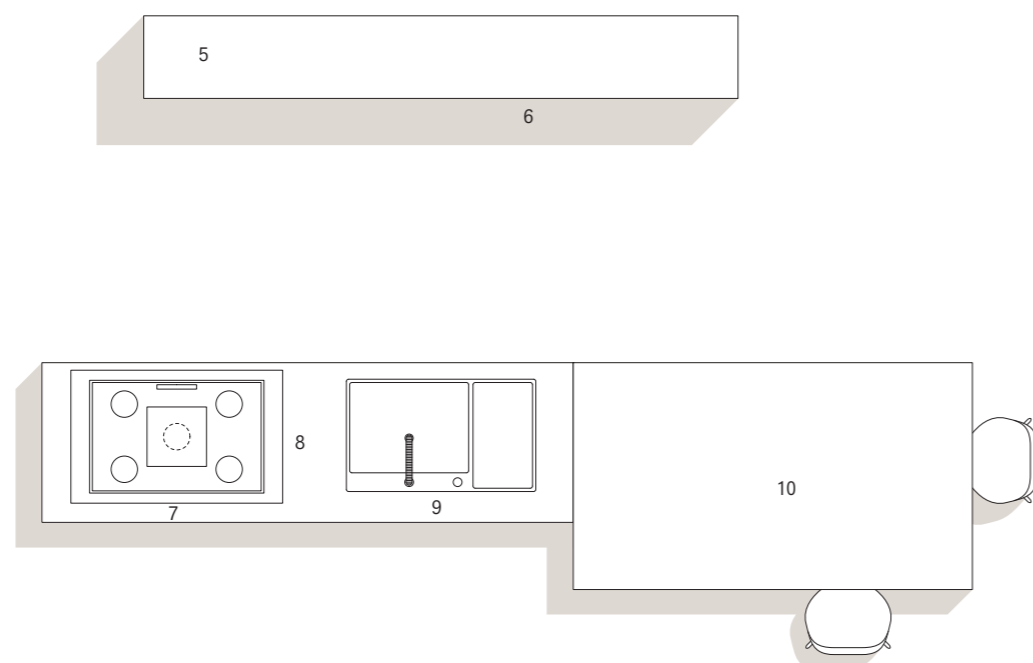
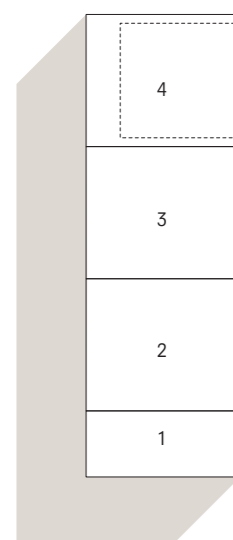

Basi e colonne con ante in *Fenix Grigio Efeso*¹ e gole in *Fenix Grigio Bromo*². Finiture invertite per le colonne sospese con elemento a giorno. Piano snack di forte spessore in *Quercia Tavolato*³.

Base and tall units with doors in *Fenix Grigio Efeso*¹ and grip recesses in *Fenix Grigio Bromo*². Inverted finishes for the hanging tall units with open element. Extra thick breakfast bar in *Quercia Tavolato*³.

- | | |
|---|---|
| 1 Colonna dispensa estraibile Tal Larder con illuminazione Led. Tal Larder pull-out pantry tall unit with LED lighting. | 6 Pensile a giorno con illuminazione Led. Open wall unit with LED lighting. |
| 2 Colonna Frigo con anta battente. Tall unit for fridge with hinged door. | 7 Piano cottura AEG. AEG Hob. |
| 3 Colonna dispensa con apertura ad anta battente con illuminazione Led. Pantry tall unit with hinged door and LED lighting. | 8 Cappa Libeccio. Libeccio Hood. |
| 4 Colonna forno e cantinetta AEG. Tall unit with AEG oven and wine cooler. | 9 Lavello e miscelatore Franke. Franke sink and mixer tap. |
| 5 Pensili con apertura anta battente e illuminazione Led. Wall units with hinged door and LED lighting. | 10 Snack in Quercia sp. 5 cm. 5cm thick breakfast bar in Quercia. |

Il potenziale progettuale di M2 Tecna si dichiara senza incertezze in questo ambiente valorizzato dalla preziosa pannellatura a parete Meson's. L'atmosfera di sobria eleganza, completata dalle colonne sospese e da un elemento pensile orizzontale di grande pulizia stilistica, viene sdrammatizzata dal piacevole banco snack in essenza.

The design potential of M2 Tecna is declared without uncertainty in this environment enhanced by the precious Meson's wall paneling. The atmosphere of sober elegance, completed by the hanging tall units and a horizontal wall unit of great stylistic cleanliness, is played down by the pleasant veneered breakfast bar.



M2 Tecna

Meson's









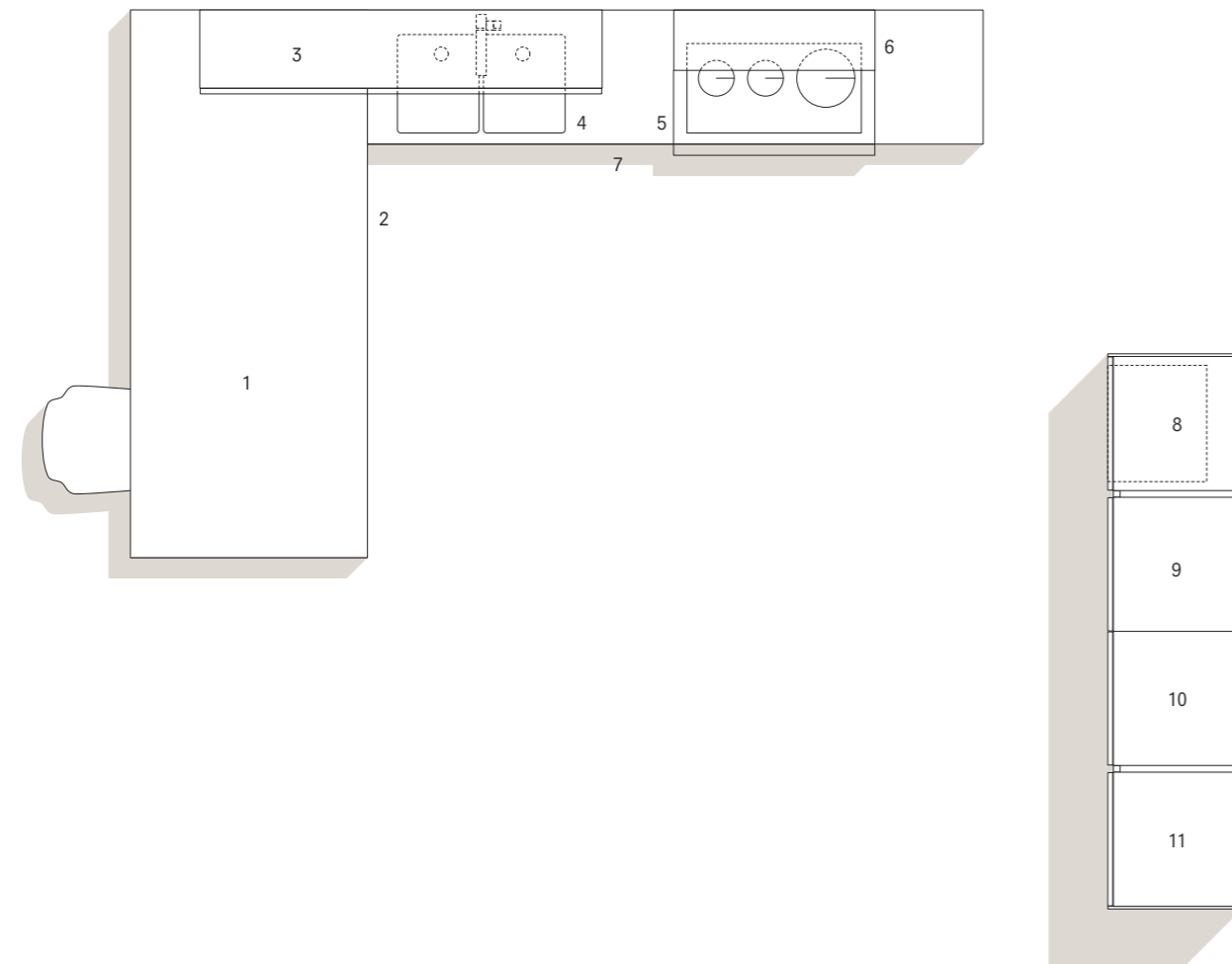

Cucina M2 Tecna con pensile e basi in finitura *Laccato Lucido Magnolia*². Banco snack in *Essenza Olmo Cenere*³. Colonne sospese in finitura *Laccato Lucido Cuoio*¹. Pannellatura parete e rivestimento cappa in *Laminato Impero*⁴.

M2 Tecna kitchen with wall unit and base units in *Magnolia Gloss Lacquer*² finish. Breakfast bar in *Olmo Cenere Veneer*³. Hanging tall units in *Cuoio Gloss Lacquer*¹ finish. Wall paneling and hood covering in *Impero Laminato*⁴.

- 1 Snack in essenza sp. 6 cm.
6 cm thick veneer breakfast bar.
- 2 Base angolo accessoriata con Flexcorner.
Equipped corner base unit with Flexcorner.
- 3 Pensile composto con apertura vasistas e illuminazione Led.
Composed wall unit with top-hung door and LED lighting.
- 4 Vasca inox integrata al top e miscelatore Franke.
Stainless steel sink integrated into the worktop and Franke mixer tap.

- 5 Piano cottura a induzione Franke.
Franke induction hob.
- 6 Cappa Maestrale in finitura Laccato Lucido Magnolia.
Maestrale hood in Magnolia Gloss Lacquered finish.
- 7 Basi pensili con catene luminose.
Wall-hung base units with lighting joint-strips.
- 8 Colonna sospesa con forno Franke.
Hanging tall unit with Franke oven.
- 9 Colonna dispensa sospesa con apertura ad anta battente e illuminazione Led.
Hanging pantry tall unit with hinged door and LED lighting.

- 10 Colonna dispensa sospesa con apertura ad anta battente e illuminazione Led.
Hanging pantry tall unit with hinged door and LED lighting.
- 11 Colonna frigo sospesa con anta battente.
Hanging tall unit for fridge with hinged door.

Una cucina nella quale la pulizia progettuale dell'insieme lascia emergere l'accuratezza costruttiva e il valore dei materiali e delle finiture. Gli elementi rettangolari orizzontali fanno *pendant* con l'eleganza degli accostamenti materici e cromatici. Una scelta perfetta per entrare nella dimensione di qualità garantita dal marchio Meson's.

A kitchen where the design cleaning of the whole brings out the constructive accuracy and the value of the materials and finishes. The horizontal rectangular elements match the elegance of the material and chromatic combinations. A perfect choice to enter the quality dimension guaranteed by the Meson's brand.







M2 Monoliti

Meson's







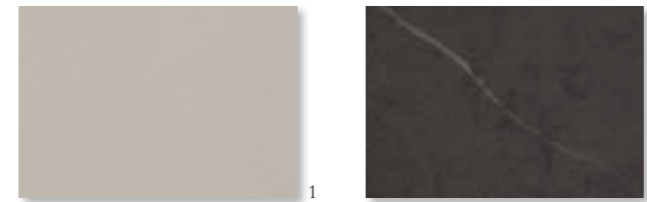
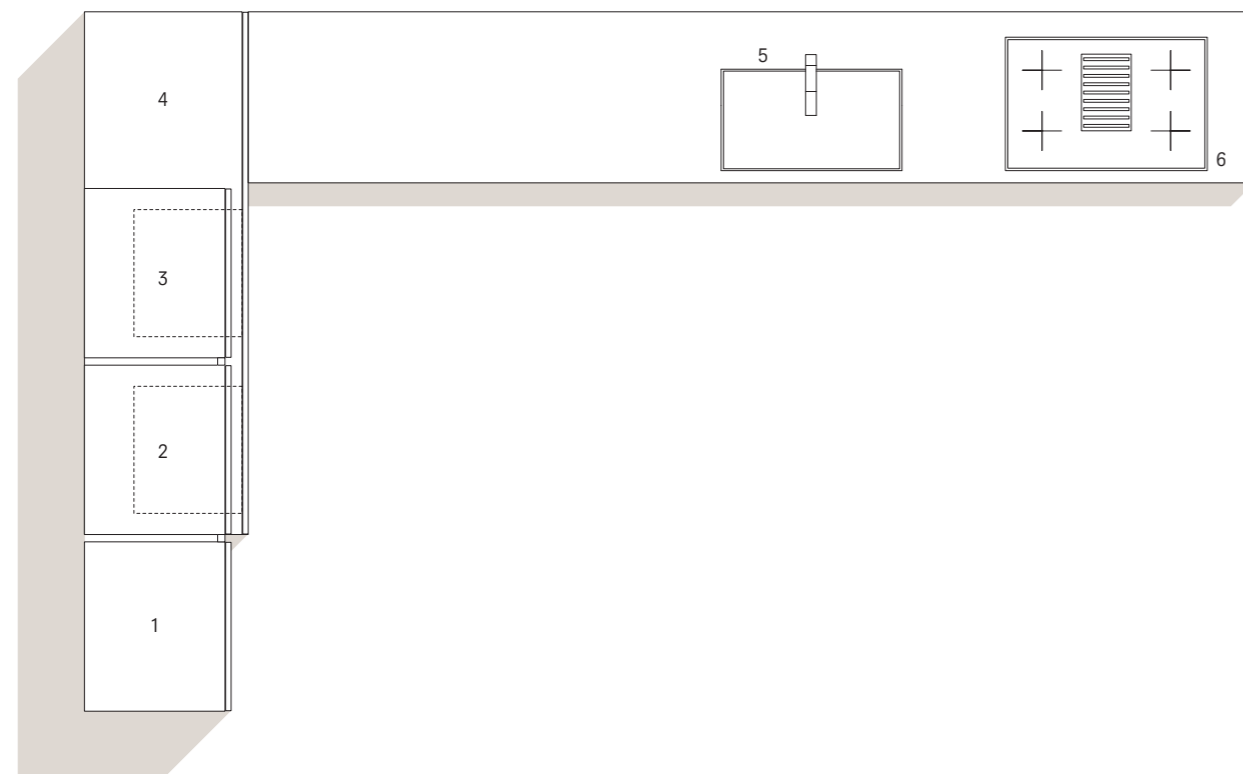

Cucina M2 Monoliti con basi e colonne in finitura *Materico Cera Grigetto*¹, elemento contenitore forni con anta planare, moduli superiori delle basi di destra a cassettoni e piano in *Laminato Tobacco*².

M2 Monoliti kitchen with base and tall units in *Cera Grigetto Textured-melamine*¹ finish, element for ovens with lift up door, upper modules of the right base units with deep drawers and worktop in *Tobacco Laminate*².

1 Colonna frigo con apertura ad anta battente.
Tall unit for fridge with hinged door.

2 Colonna e sopracolonna dispensa con apertura ad anta battente e illuminazione Led.
Pantry tall unit and top element with hinged door and LED lighting.

3 Colonna e sopracolonna dispensa con apertura ad anta battente accessoriata con cestoni interni e illuminazione Led.
Pantry tall unit and top element with hinged door equipped with internal deep drawers and LED lighting.

4 Elemento sporgente con apertura planare verticale e forni ad incasso Neff.
Jutting element with lift up door and Neff built-in ovens.

5 Vasca integrata in laminato Tobacco e miscelatore Foster.
Integrated sink basin in Tobacco laminate and Foster mixer tap.

6 Piano cottura con aspirazione integrata Neff.
Hob with Neff integrated suction.

Materico Muro Natura /
Fenix Beige Arizona /
Laminato Lamiera

La ricerca di un'eleganza borghese non convenzionale traspare nelle scelte di soluzioni e materiali adottati per gli interni di questa abitazione. La delicata morbidezza della finitura *muro* delle colonne, la forte personalità del top e la preziosa colonna bar a parete suggeriscono uno spazio nel quale la cucina, oltre che luogo della preparazione del cibo, è accogliente punto d'incontro.

The search for non-conventional bourgeois elegance shines through the choices of solutions and materials adopted for the interiors of this house. The delicate softness of the *muro* finish of the tall units, the strong personality of the worktop and the precious wall bar tall unit suggest a space in which the kitchen, as well as a place for preparing food, is a welcoming meeting point.







M2 Monoliti

Meson's





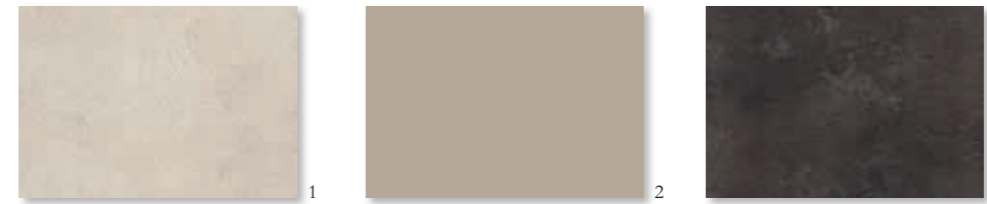
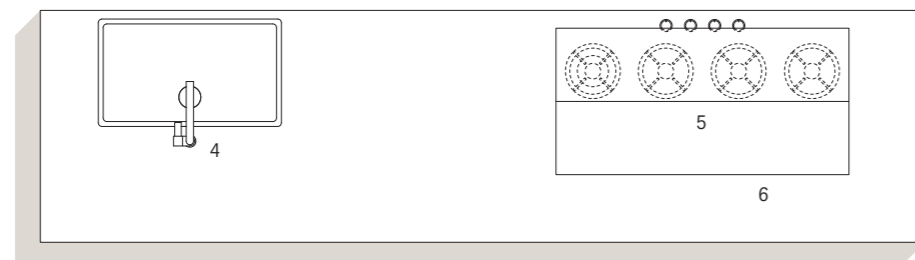
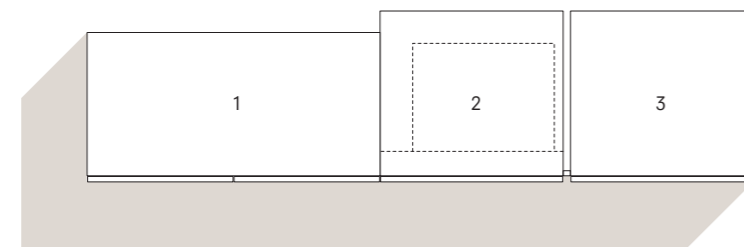

Colonne Monoliti in *Materico Muro Natura*¹, colonna bar con anta C_rystal. Isola con ante e fianchi *Fenix Beige Arizona*², blocco superiore con piano integrato in *Laminato Lamiera*³.

Monoliti tall units in *Muro Natura Textured-melamine*¹, bar tall unit with C_rystal door. Island with doors and side panels in *Fenix Beige Arizona*², upper block with integrated worktop in *Lamina Laminata*³.

1 Colonna Bar ante C_rystal battenti.
"Bar tall unit" with C_rystal hinged doors.

2 Colonna con forni nascosti all'interno Whirlpool.
Tall unit with Whirlpool ovens hidden inside.

3 Colonna frigo con anta battente.
Tall unit for fridge with hinged door.

4 Lavello e miscelatore Gun Metal Foster.
Foster Gun Metal sink and mixer tap.

5 Bruciatori PITT.
PITT Burners.

6 Cappa Scirocco ad Isola.
Scirocco Island Hood.

M2 Meson's offre 6 diverse tipologie di anta e numerose opzioni di finiture, componibilità e accessori. Meson's M2 offers 6 different types of doors and many options for finishes, modularity and accessories.

Goccia

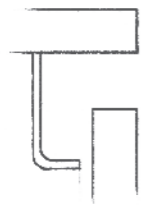

Prerogativa tipica del design Meson's, la gola di Goccia offre una comoda presa e crea un effetto di leggerezza e sospensione tra basi e top.

A typical prerogative of Meson's design, the Goccia grip recess offers a comfortable grip and creates an effect of lightness and suspension between base units and worktop.



Linea



Un profilo di apertura in alluminio orizzontale o verticale, in colore a contrasto o tono su tono, che permette infinite combinazioni grafiche e cromatiche.

An aluminium opening profile, horizontal or vertical, in contrasting colour or tone on tone, which allows endless graphic and chromatic combinations.



Monoliti



In questo progetto, concepito per realizzare forme pure, la percezione di spessori sottili è ottenuta con la lavorazione dei bordi di top e anta.

In this project, designed to create pure forms, the perception of thin thicknesses is obtained by processing the edges of worktop and door.



Crea

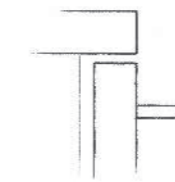

Crea è una tipologia di anta che prevede l'utilizzo della maniglia esterna, elemento che aggiunge un importante segno al design della composizione.

Crea is a type of door that uses the external handle, an element that adds an important sign to the design of the composition.



Tecna

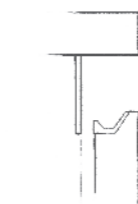

Il profilo integrato nel bordo superiore del frontale è il dettaglio esclusivo che firma questa preziosa anta M2.

The profile integrated in the upper edge of the front is the exclusive detail which signs this precious M2 door.



Memo

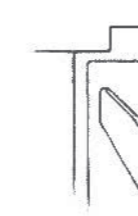

Memo è un'anta telaio nella quale il massello superiore, lavorato con eleganza, accoglie un profilo che sottolinea il punto di presa. Un classico moderno.

Memo is a frame door in which the upper solid wood, processed with elegance, integrates a profile that emphasizes the grip point. A classic modern.



Materici / Melamine

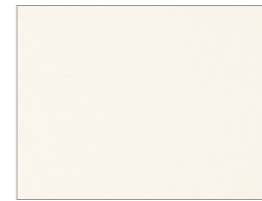

Cera Latte



Cera Vanilla



Cera Grigetto



Cera Toffee



Muro Bianco



Muro Natura



Muro Tortora



Muro Terra

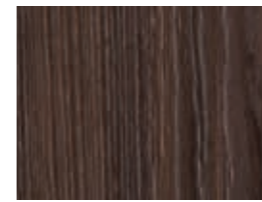

Larice Bistro



Larice Nero



Rovere Badia



Cemento

Materici Plus / Melamine Plus



Grigio Etna



Grigio Grafite

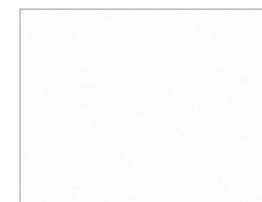

Bianco

Laminati / Laminates



Malta Bianca



Malta Grigia



Malta Canapa



Tadao



Ruggine



Corten



Lamiera



Tabacco

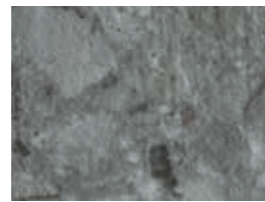

Mailand



Impero



Calacatta



Palladio



Botticino

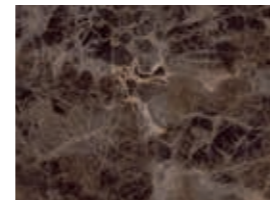

Emperador



Canova

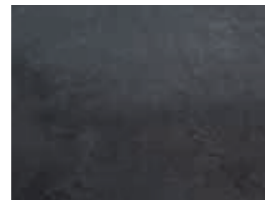

Nero Ardesia



Rovere California



Rovere Monet



Rovere Slavonia

Fenix

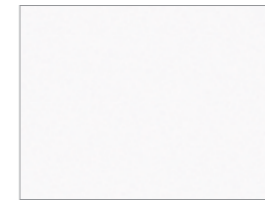

Alaska



Bianco Kos

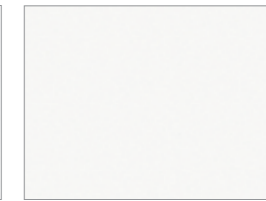

Bianco



Grigio Efeso



Beige Arizona



Castoro



Grigio Antrim

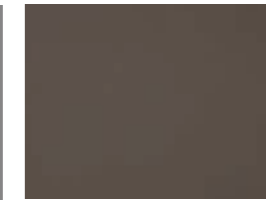

Grigio



Verde Comodoro



Rosso Jaipur



Blu Fes



Grigio Bromo



Cacao Orinoco



Nero

Laccati Opachi Seta / Seta Matt Laquers



Iceland



Wien



Manila

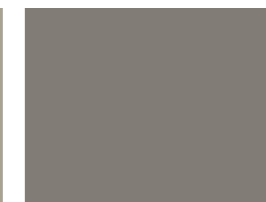

Detroit

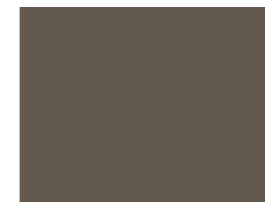

Kenia

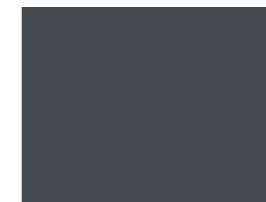

Berlin

Laccati Lucidi e Opachi / Gloss and Matt Laquers



Artico

Magnolia

Grigio Corda

Polvere



Ardesia

Piombo

Titanio

Ferro

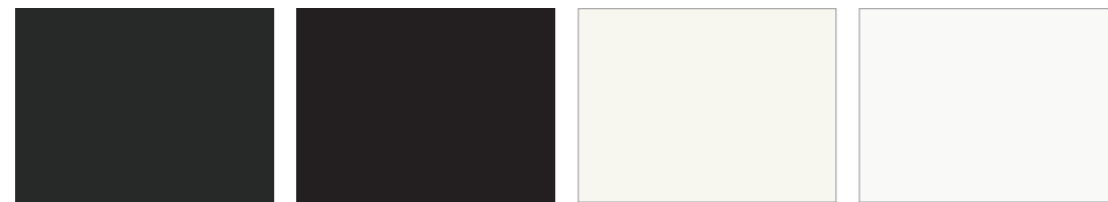

Antracite

Nero

Diamante

Bianco 10



Burro

Ecu

Canapa

Juta



Seppia

Terracotta

Londra

Visone



Creta

Terranova

Riace

Zolfo



Senape

Zucca

Ghiaccio

Carta da Zucchero



Cobalto

Petrolio

Maranello

Cuoio



Amarena

Prugna

Brown

Relax



Verde prato

Muschio

Aftereight

Colori RAL su richiesta
RAL colors on request

Laccati Metallici / Metallic Laquers

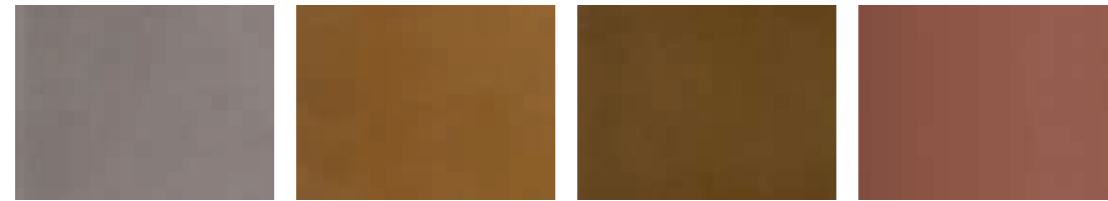

Peltro

Ottone

Bronzeo

Rame



Peltro Vintage

Ottone Vintage

Bronzeo Vintage

Impiallaciati Rovere Colore / Coloured Oak Veneer



Rovere Gesso

Rovere Argilla

Rovere Cenere

Rovere Grigio



Rovere Brown

Rovere Carbone

Essenze / Veneers



Rovere Termotrattato

Rovere Nodato Naturale

Rovere Nodato Caramel

Rovere Nodato Argilla



Rovere Nodato Scuro



Olmo Naturale

Olmo Gesso

Olmo Tabacco

Olmo Cenere



Olmo Fumo

Olmo Grigio

Olmo Lava

Acciaio / Steel



Acciaio

MESON'S

Questo catalogo è oggetto di copyright®. Tutti i diritti di immagini e contenuti sono riservati e appartengono agli autori e a Meson's Cucine srl. L'eventuale riproduzione, anche parziale, dei contenuti dovrà essere richiesta e autorizzata per iscritto dalla Meson's Cucine srl.

This catalogue is protected by a copyright®. All the rights and images contained herein are reserved and belong to the authors and to Meson's Cucine srl. Reproduction, even partial, of the contents must be requested and authorised in writing by Meson's Cucine srl.

design e testi
adsGlen

styling
Doris Andreutti
(pagina 88, 98, 110, 122 e 136)
Annalisa Bressan
(pagina 34, 48 e 62)
Valentina Brunetta
(pagina 8, 22 e 76)

luce e direzione fotografica
Alessandro Bon (pn)

render
Meson's staff

fotolito e stampa
Lucegroup.it

Meson's Cucine srl
Via Gradisca, 1
33087 Pasiano di Pordenone
Pordenone, Italy
T +39 0434 614911
F +39 0434 628042
www.mesons.it

Servizio clienti
T +39 0434 614900
F +39 0434 628042
studiomesons@mesons.it

Servizio Utenti
T +39 0434 614923
F +39 0434 628042

International department
T +39 0434 614972
F +39 0434 628042
studiomesons@mesons.it



D00BC58

